

# CHARACTERS

## ■ ウルフ教官

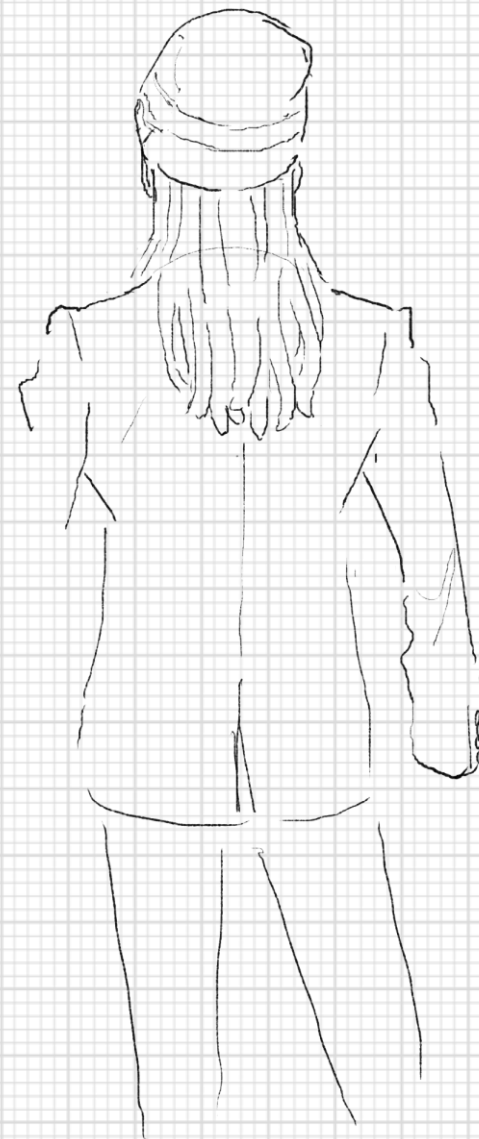

## ■九世正宗

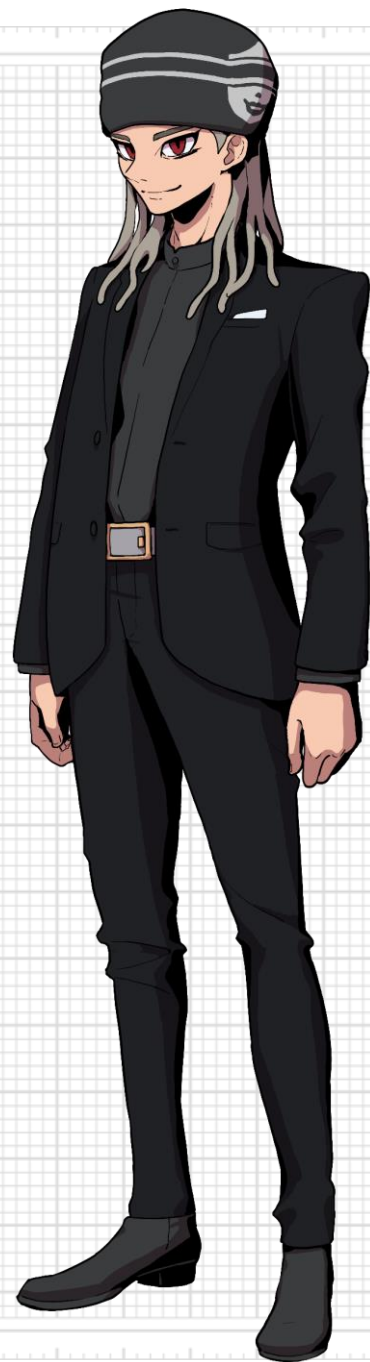
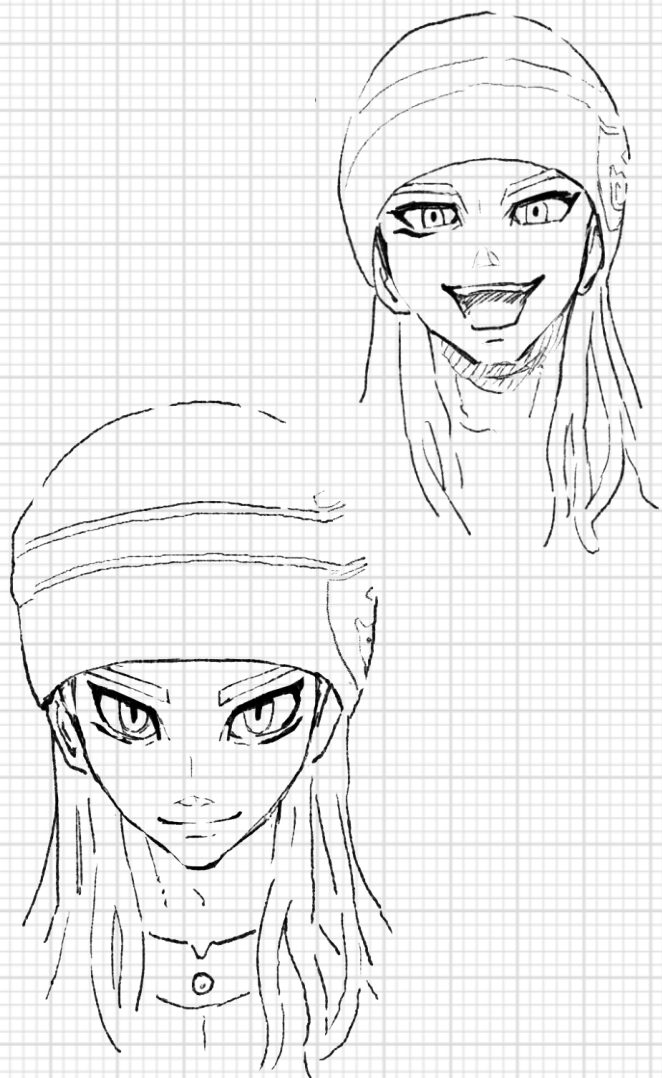



## ■ 万波シズカ

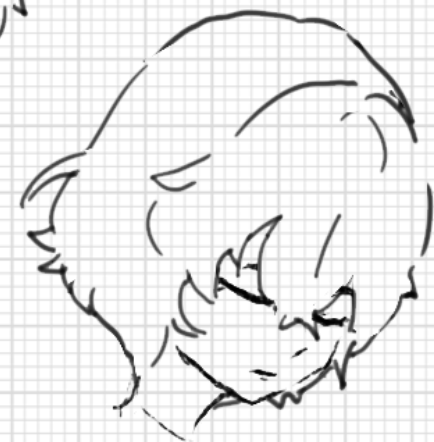
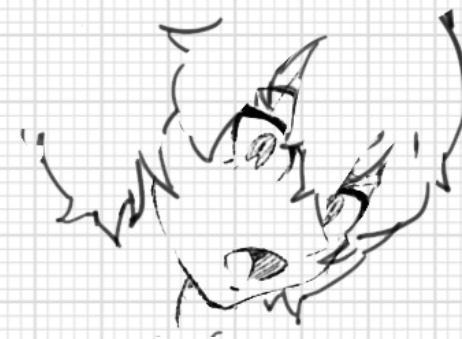
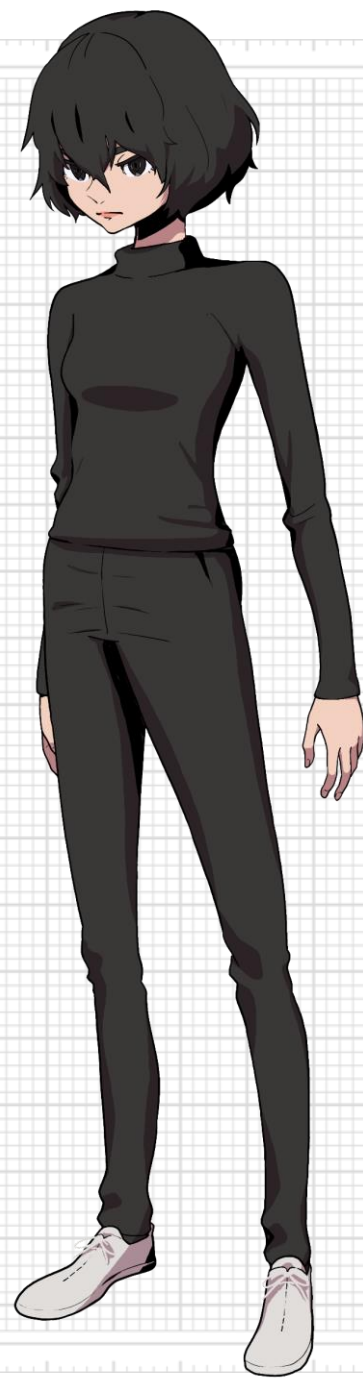



## ■ ジョニー・パーツとその一味 (二人)

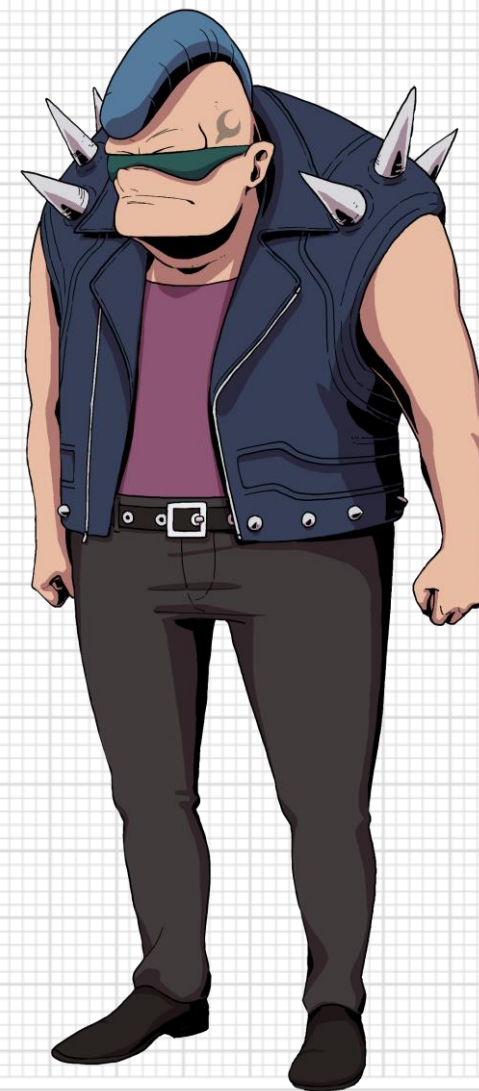
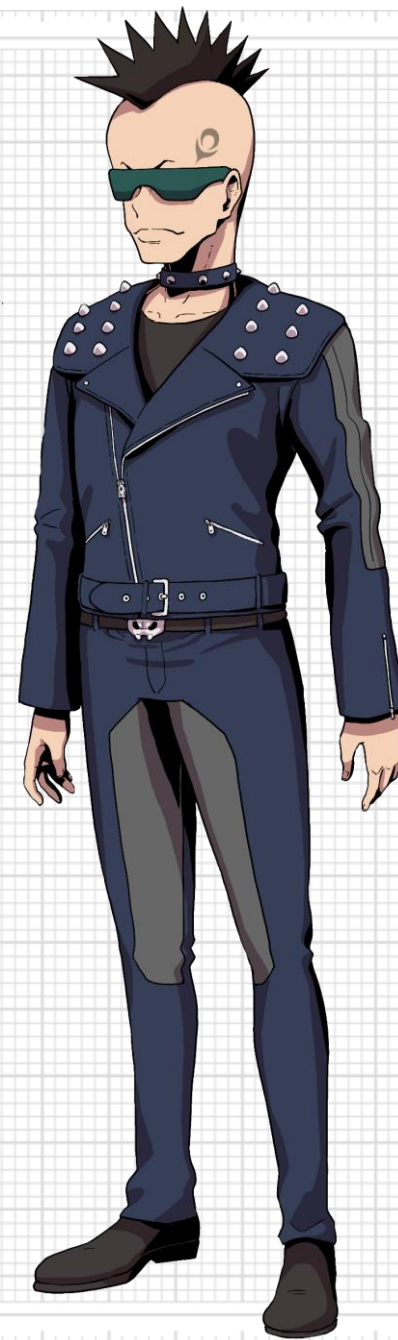
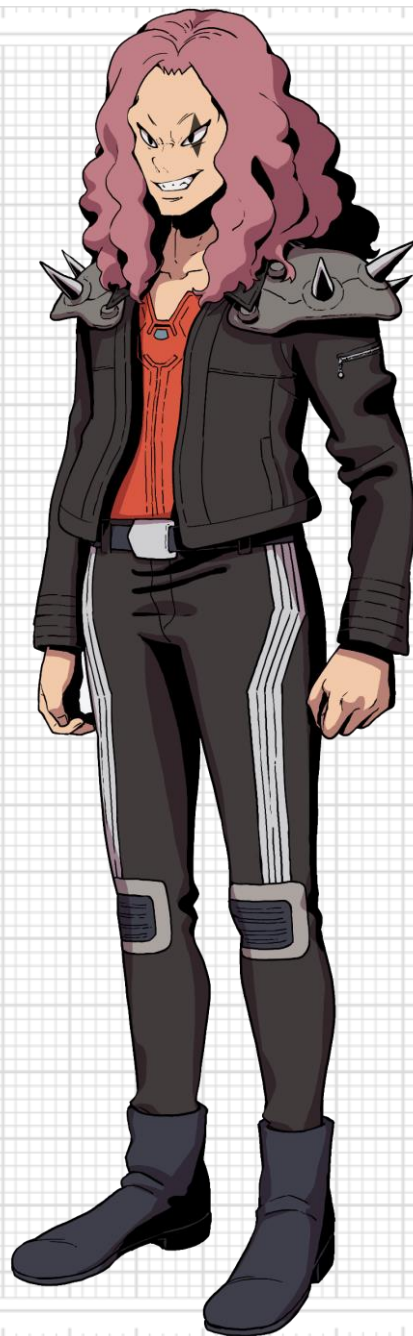

## ■ リウ・タネンと祖母

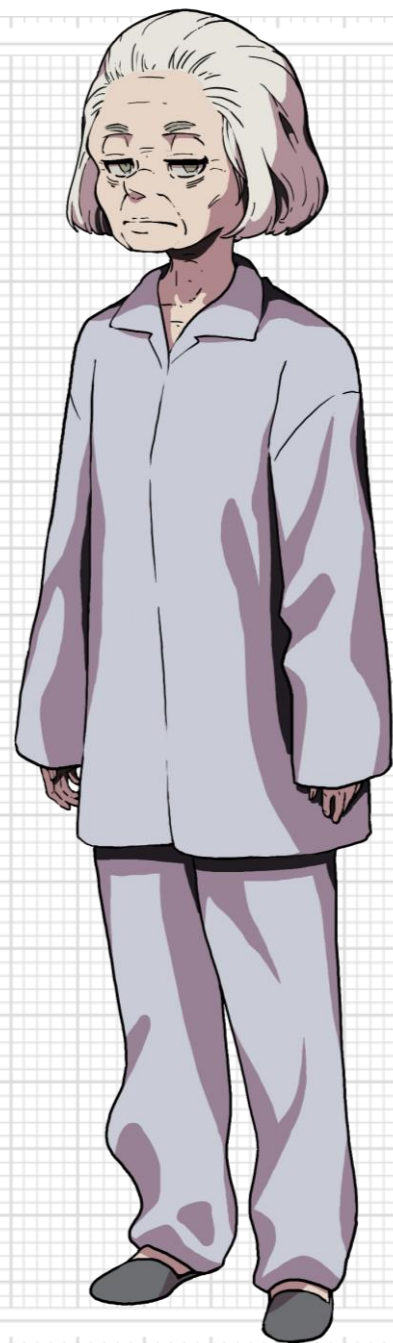



## ■アーシェム・ライア（新コスチューム）

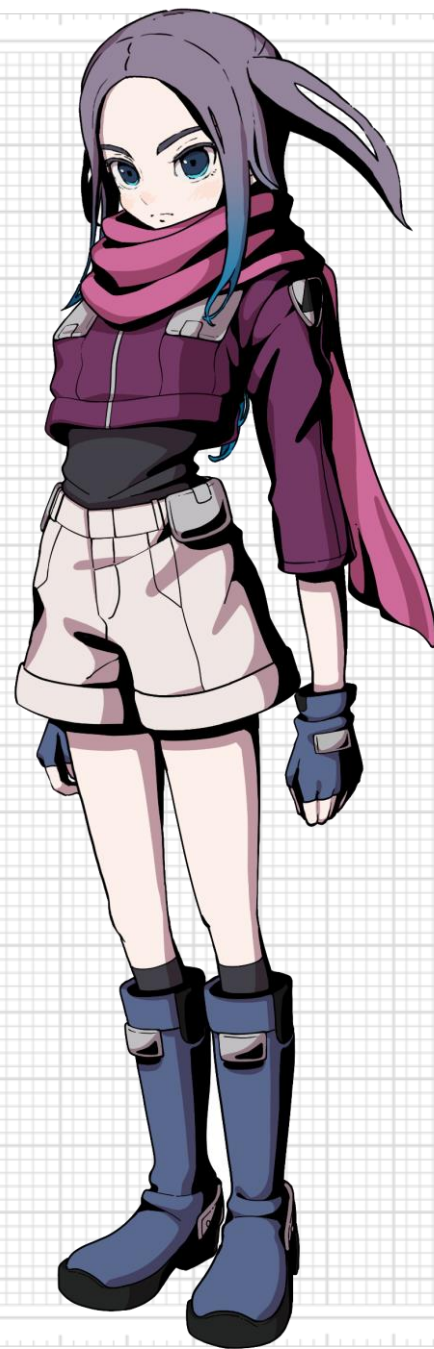



■ ミーシス・ナタール

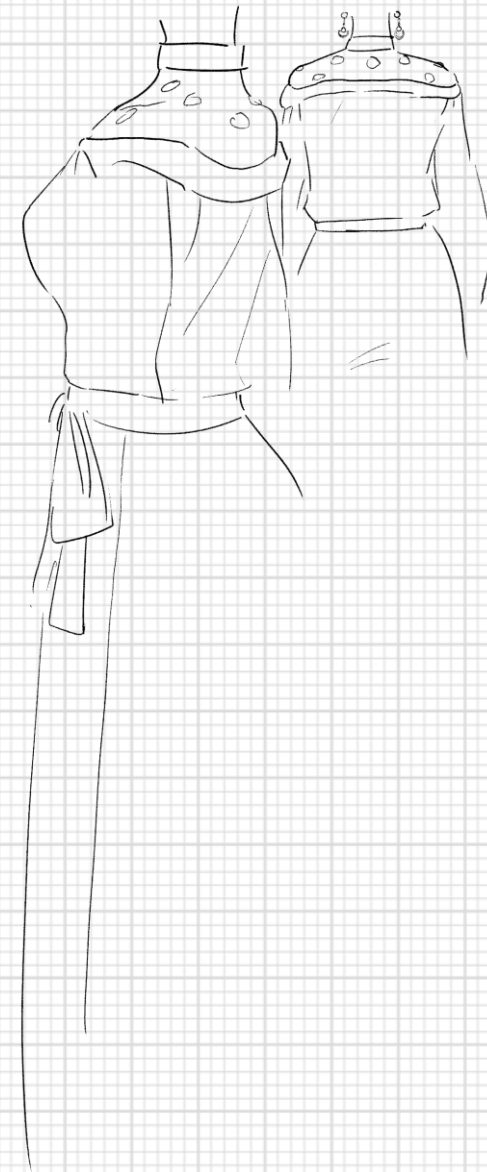
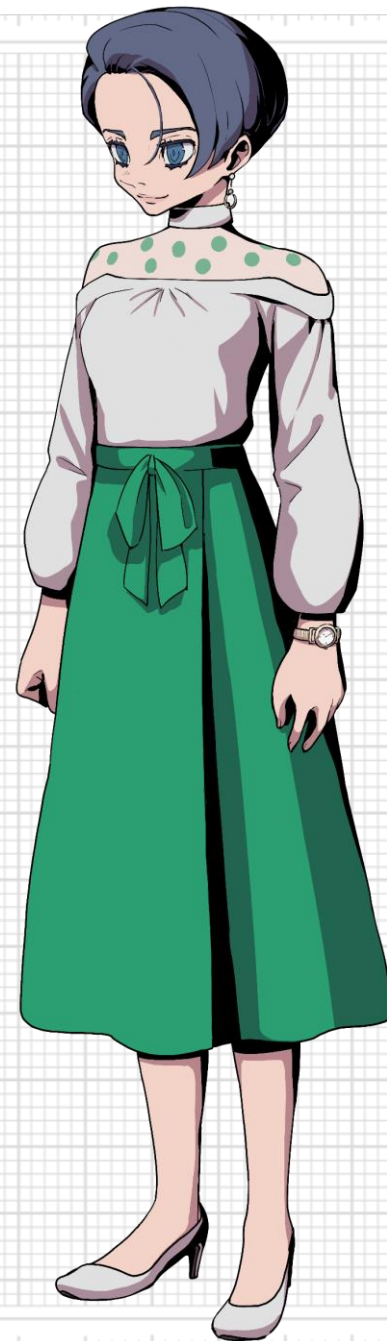
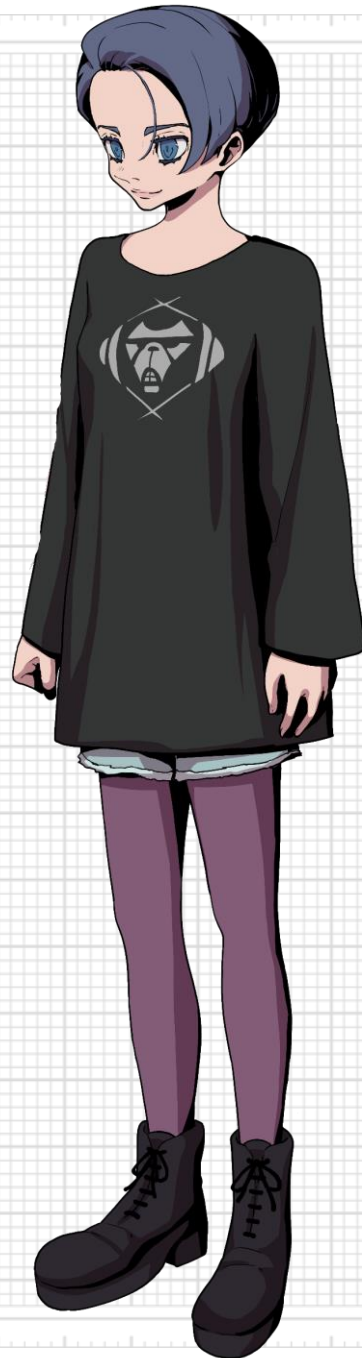

## ■ ユグラ・デファングル

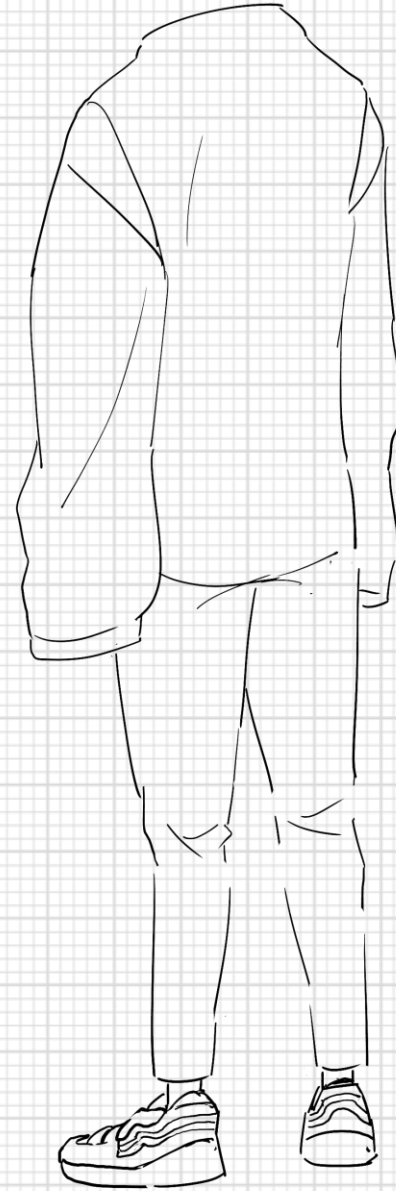

## ■グリファース (皇帝衣装)

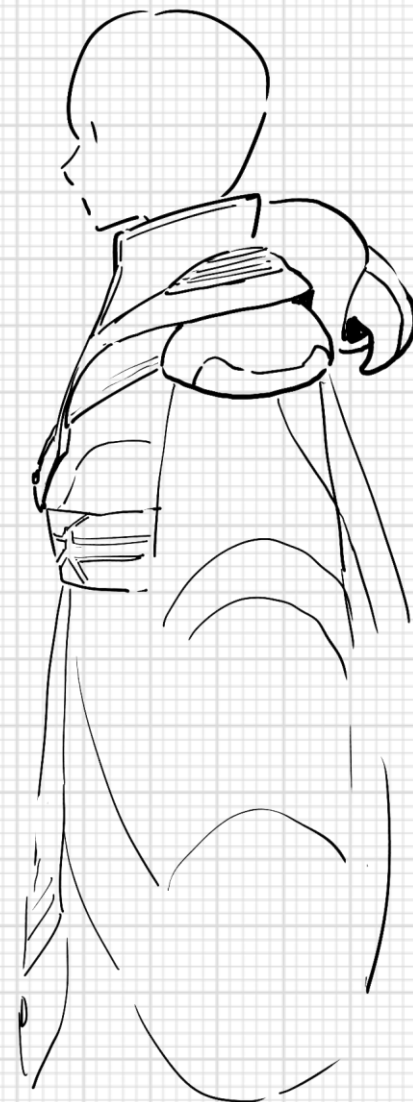
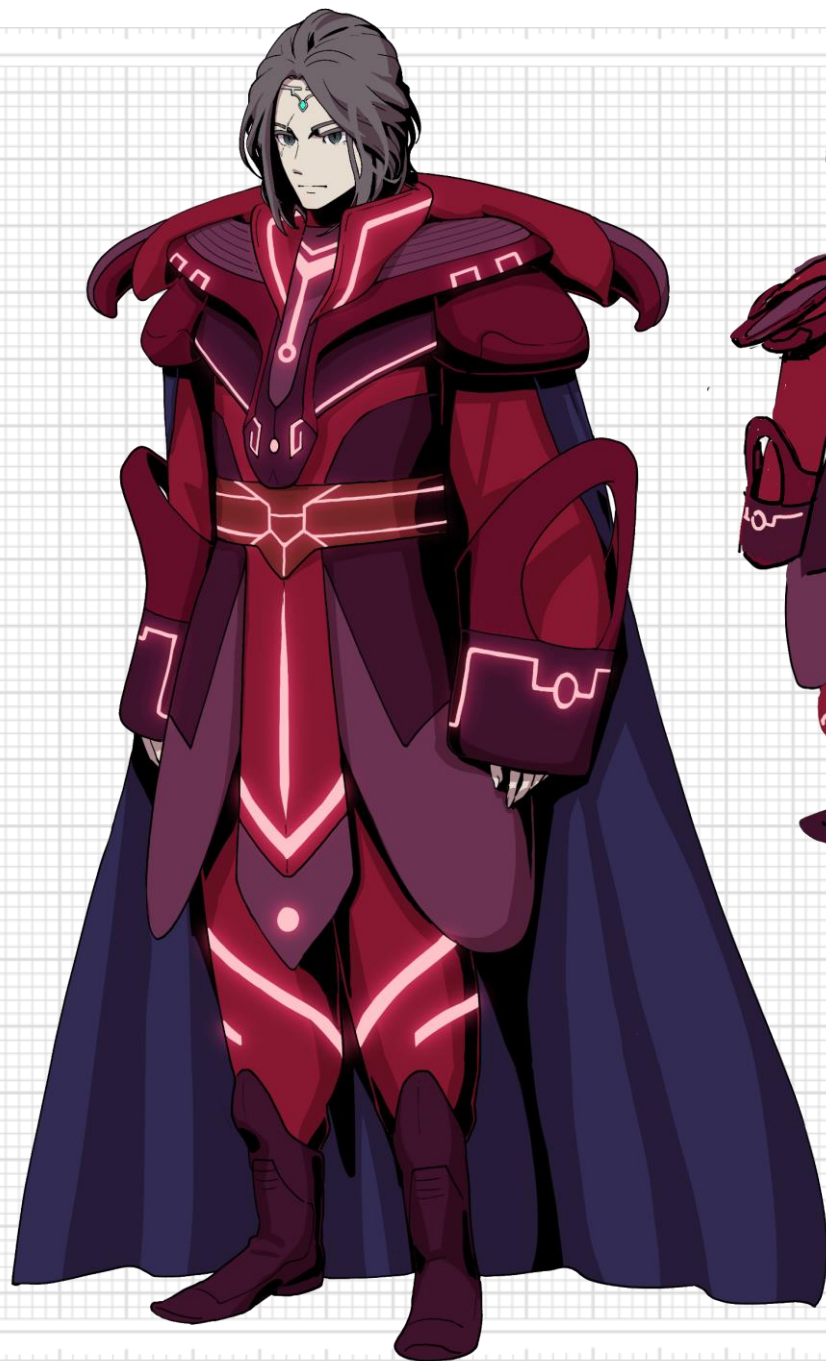



## ■ シノアグ

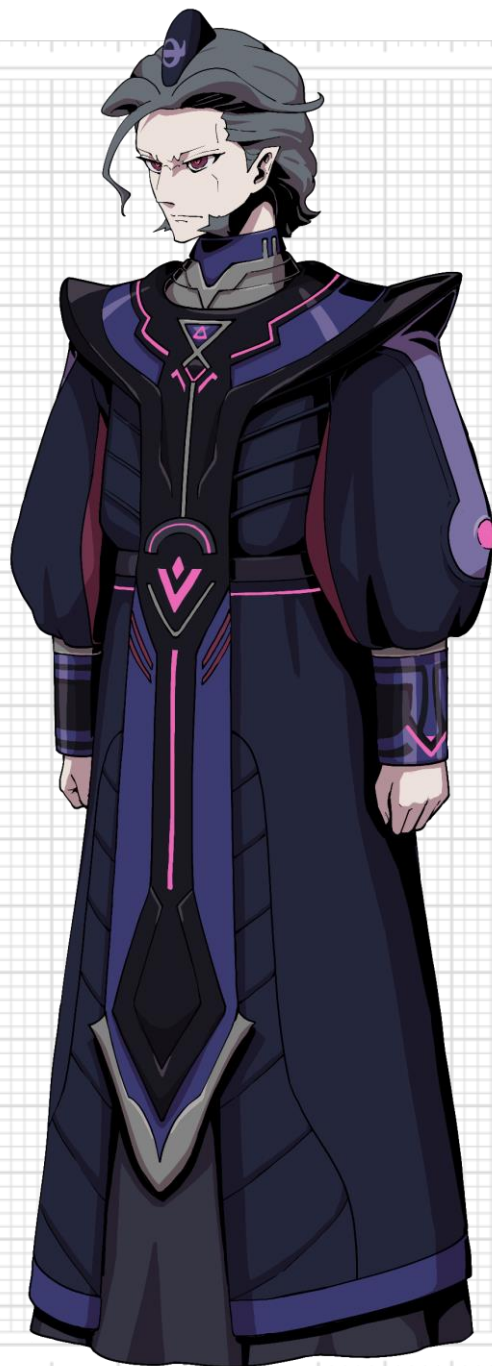

## ■ ベローア・ギデス

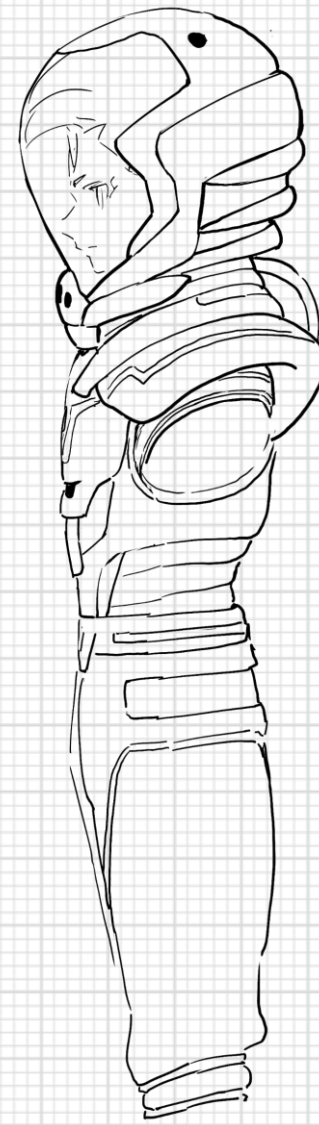
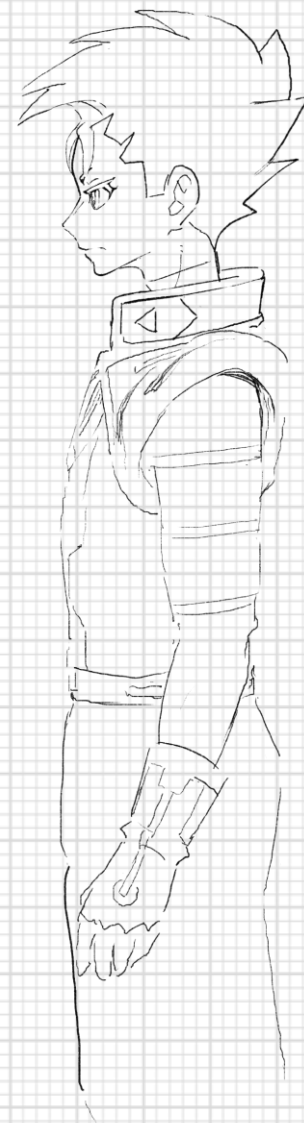



## ■ クロウゼード・ライア (コート)

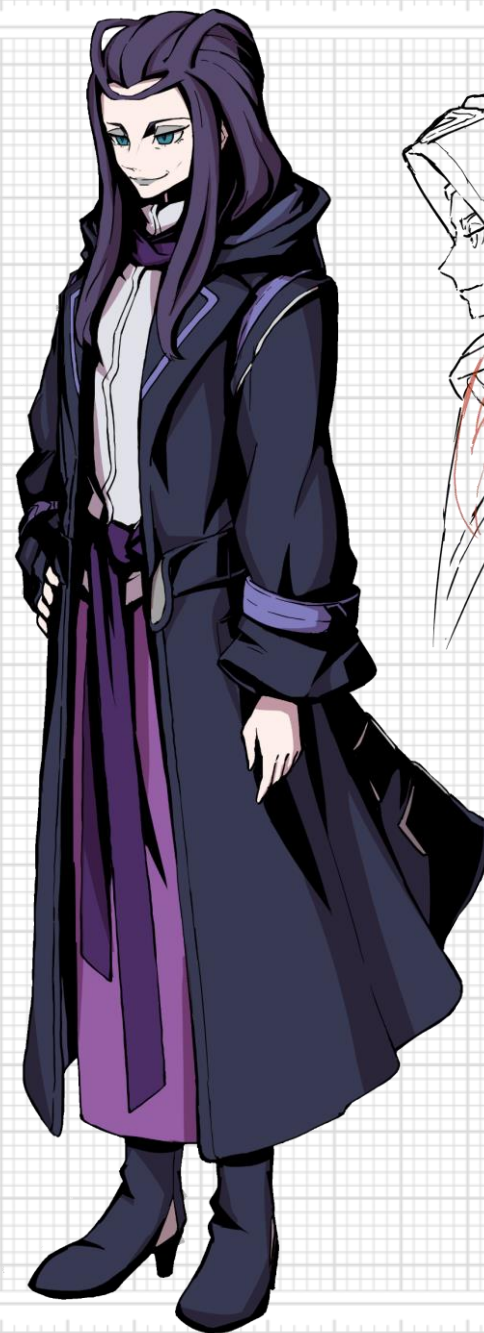
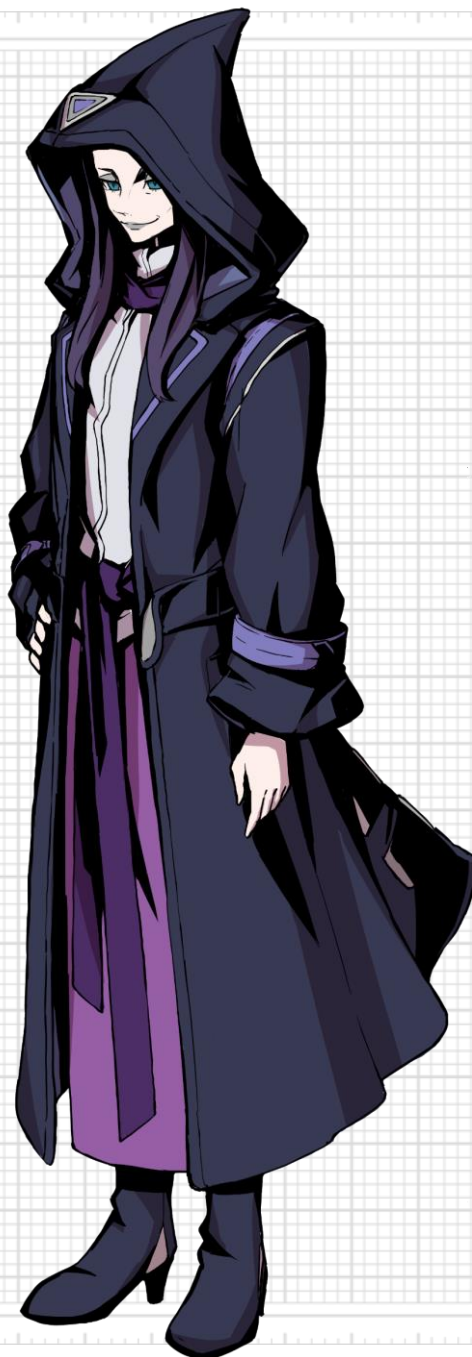



## ■デミル (コート)

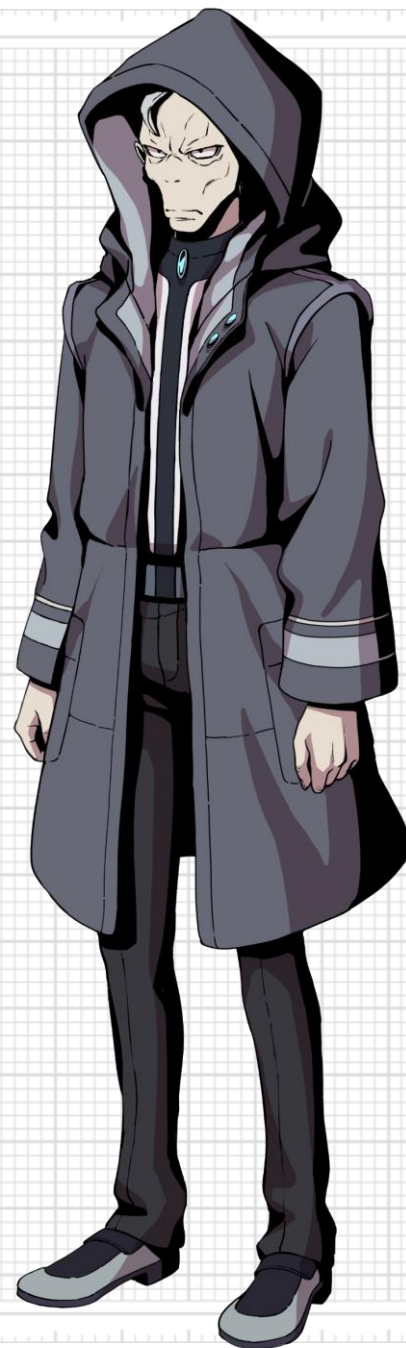
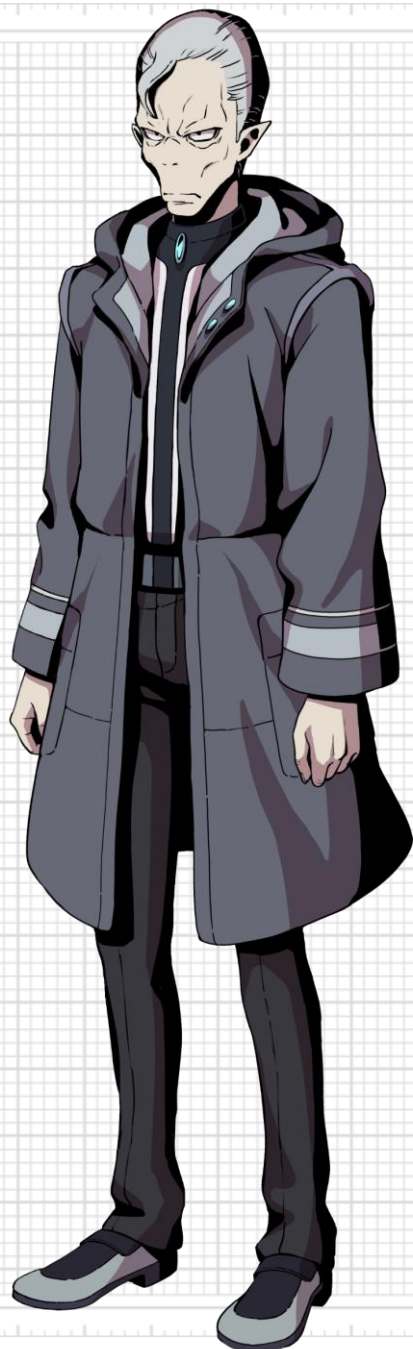

**ROGUE**



■ムサシクロス

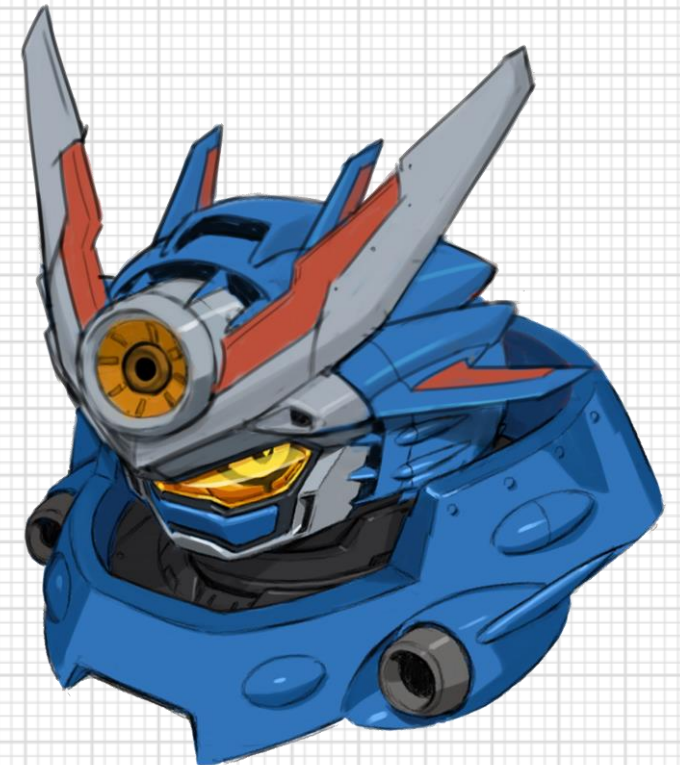
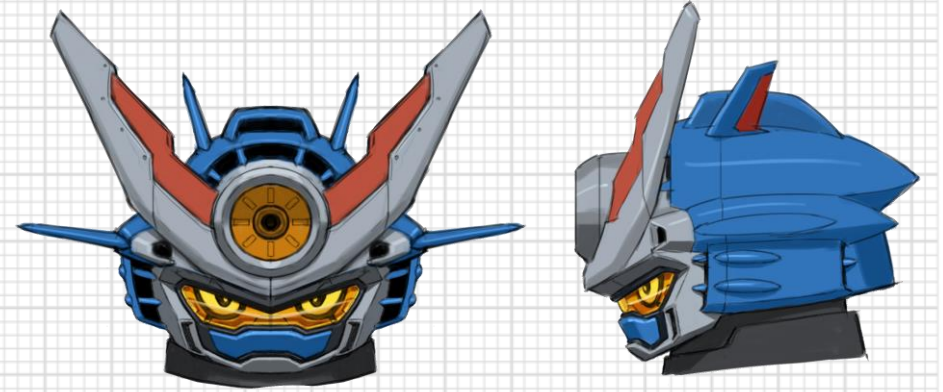
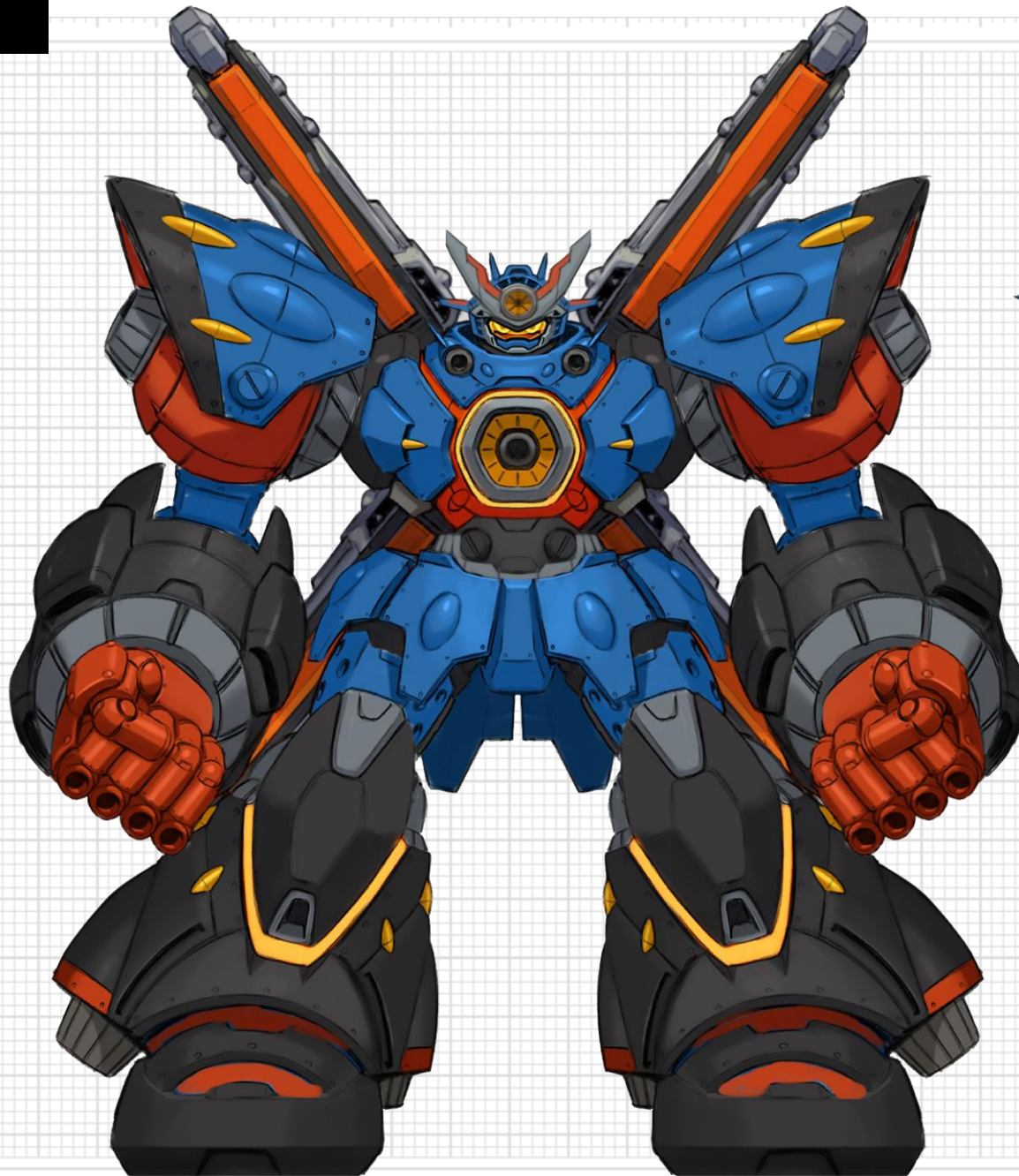



■ムサシクロス

1号機 クロスウィング

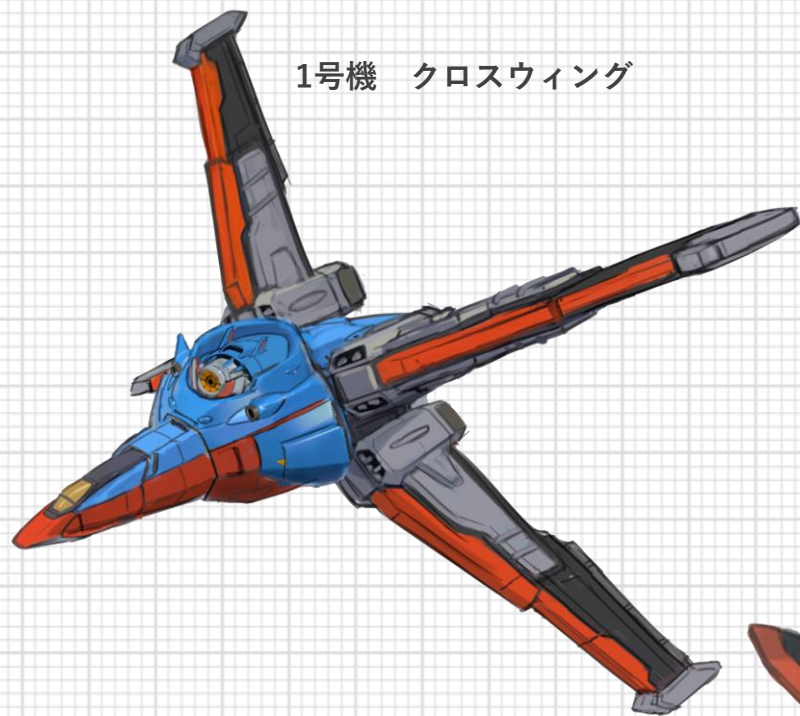

2号機 クロスダイバー

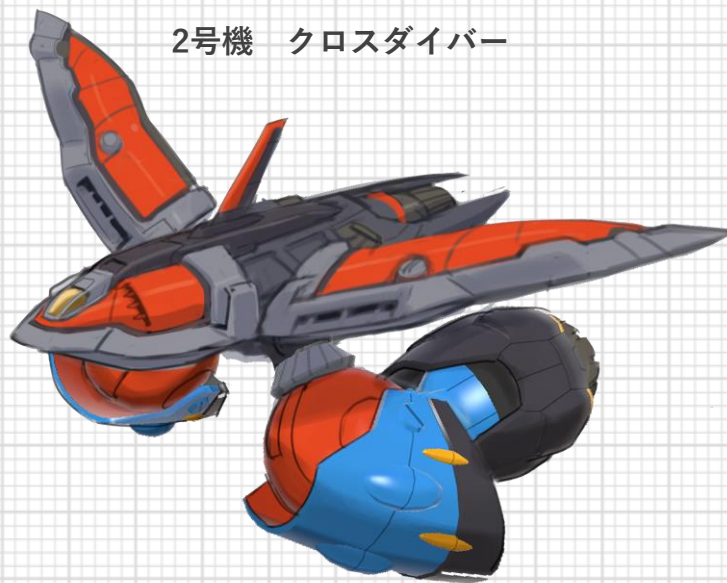

3号機 クロスセプター

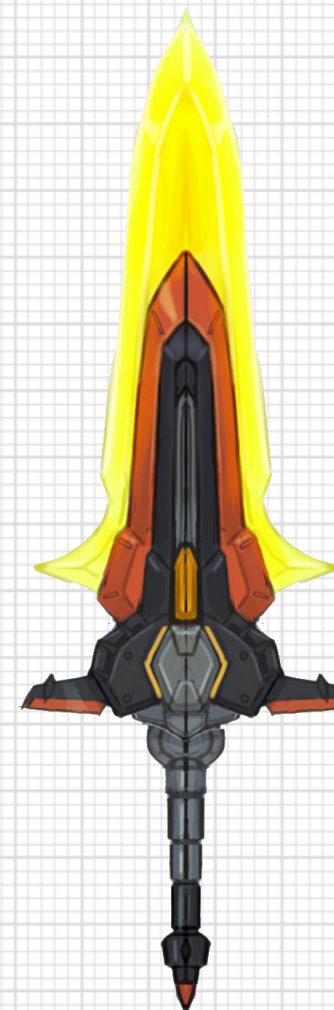
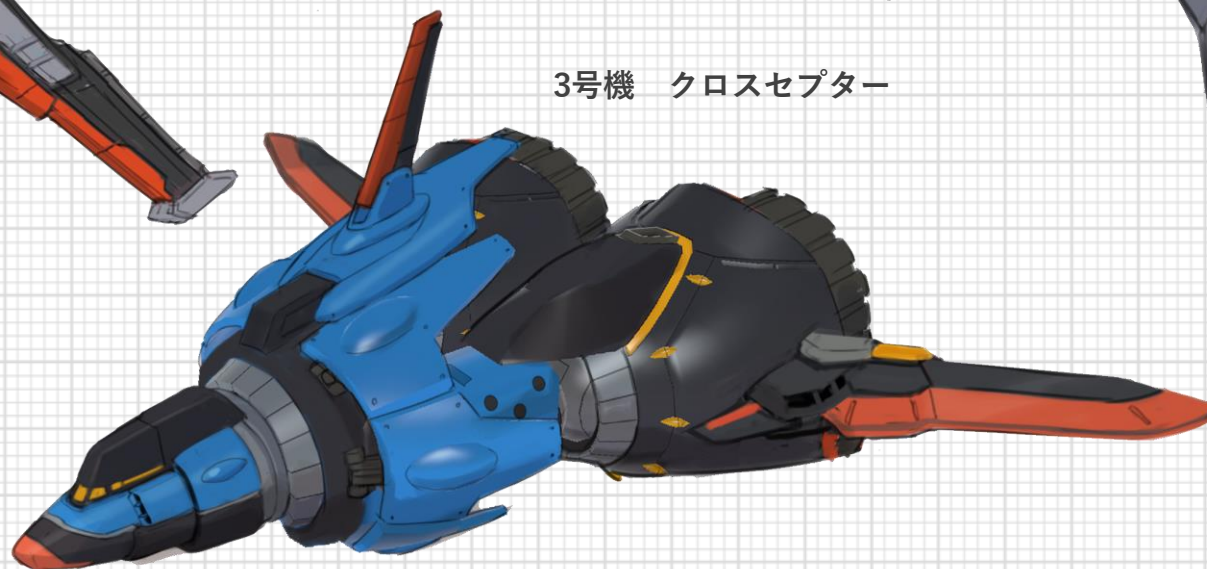

■ムサシクロス

1号機 クロスウィング

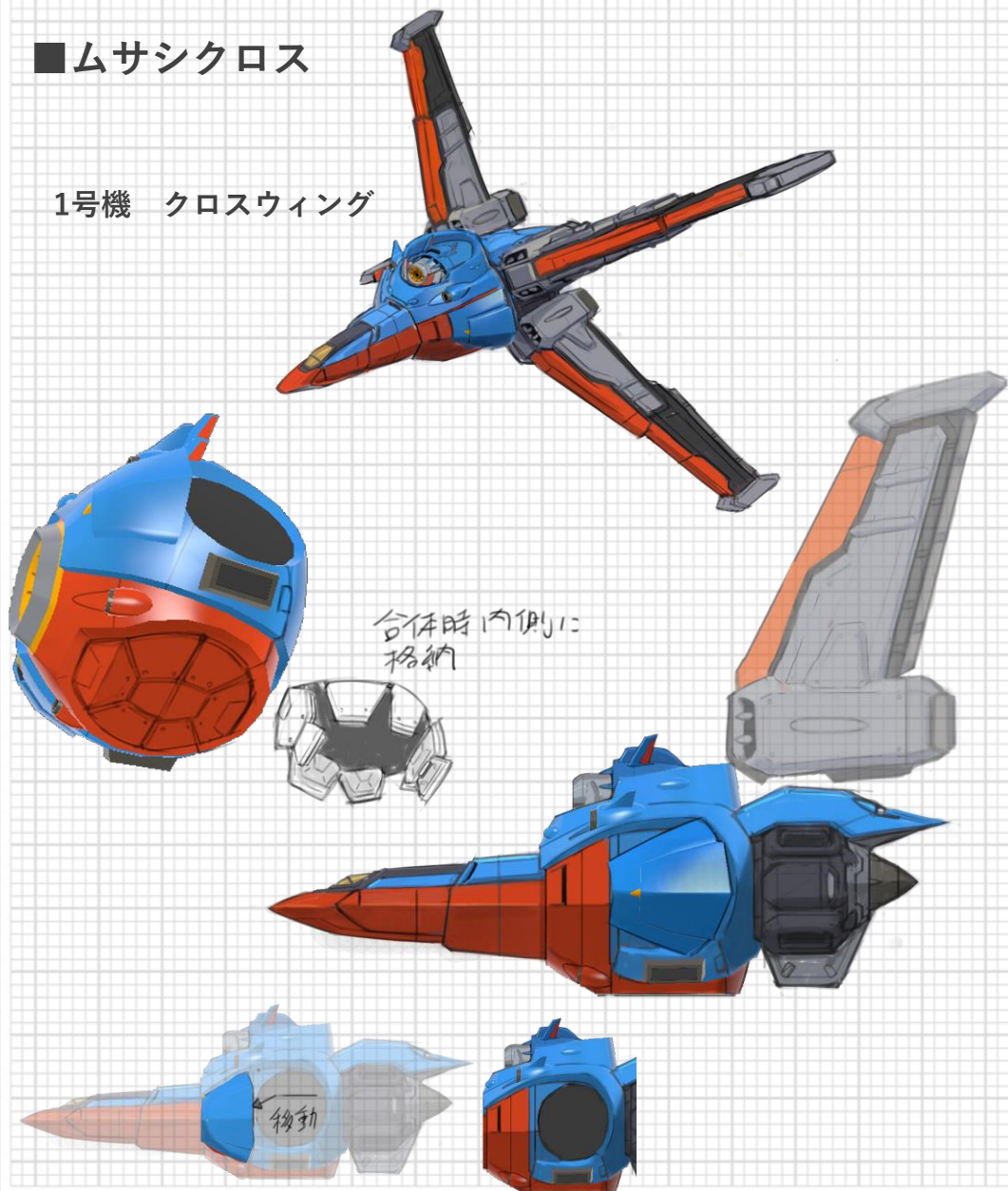

2号機 クロスダイバー

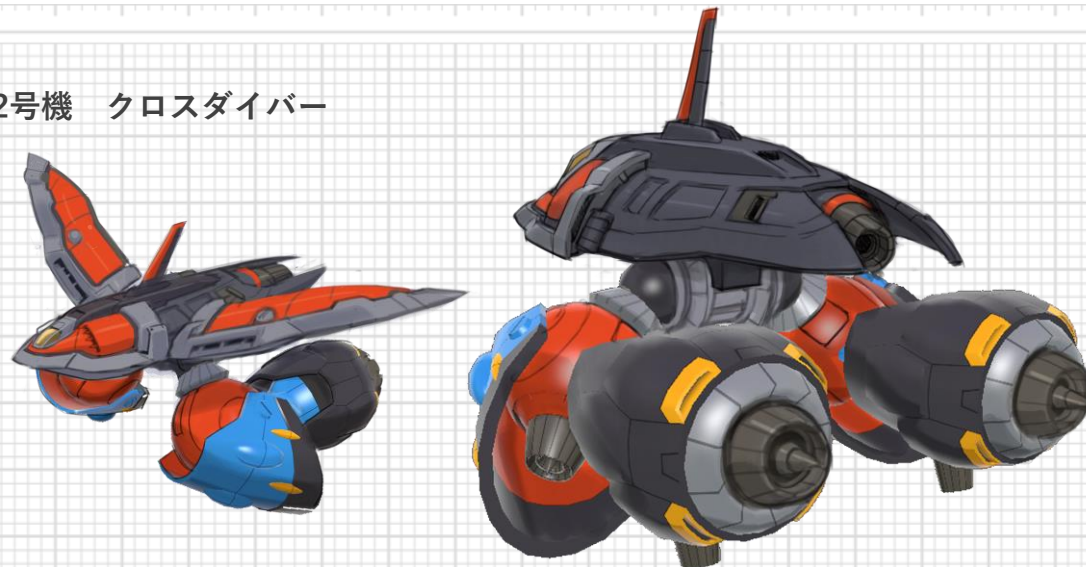

3号機 クロスセプター

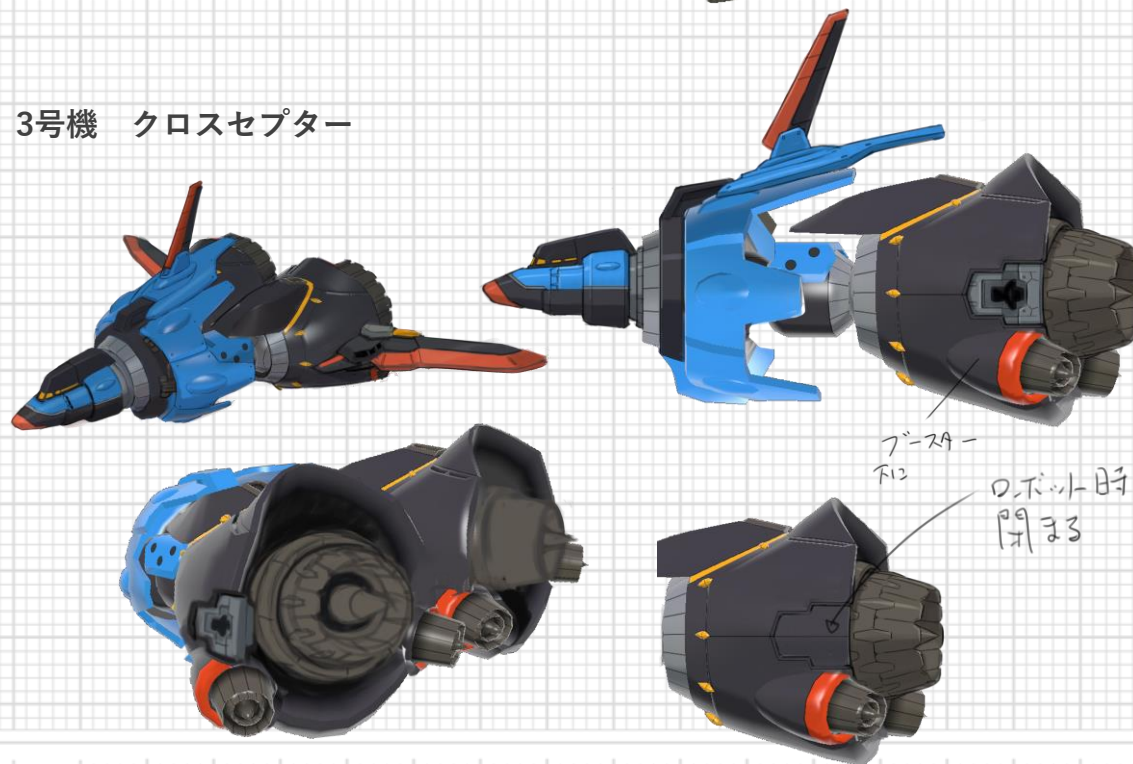



■ムサシクロス

ムサシクロスコックピット

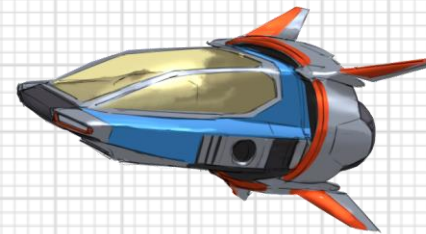
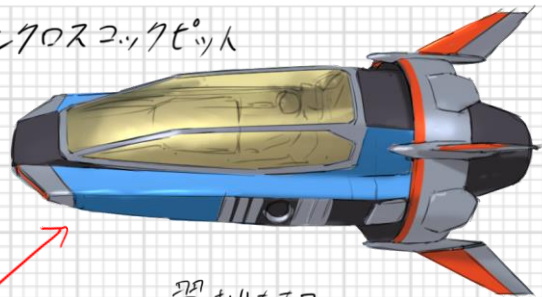

翼おりのたみ



前方

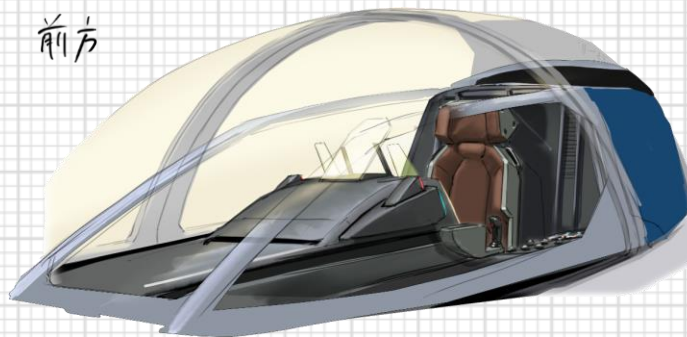

後方

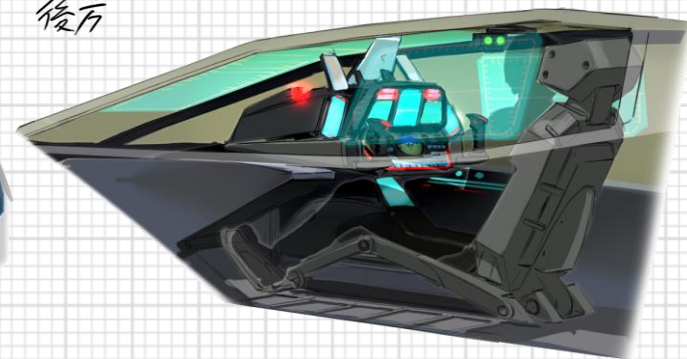

HUD

シート

操縦桿

レバー

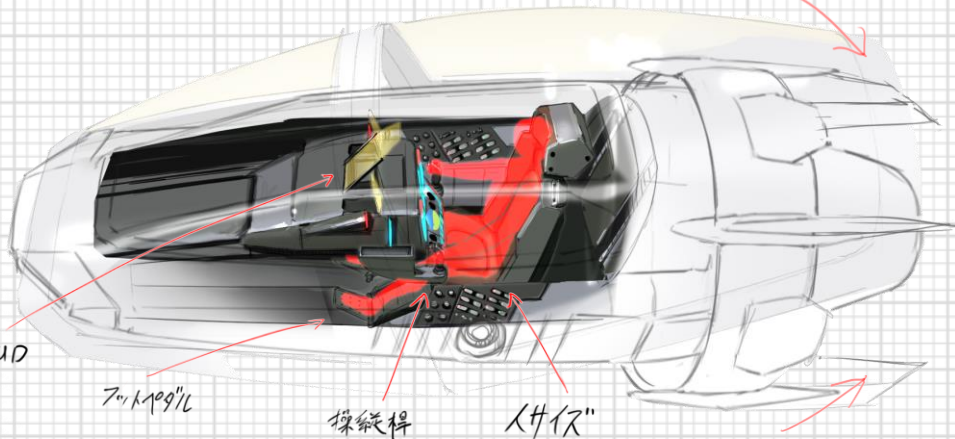

各ホック 22に 入ります。

1号機

2号機

3号機

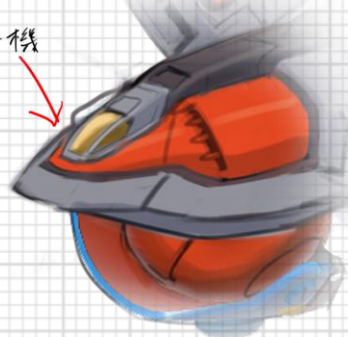
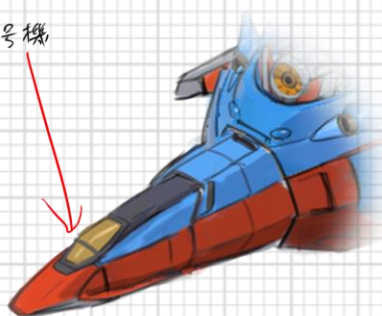

操縦桿 7"11ツ?

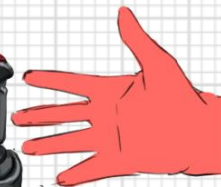



■ ムサシオー

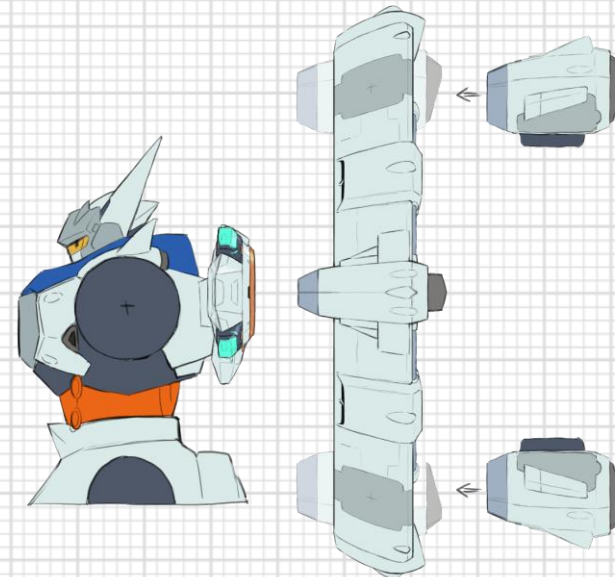
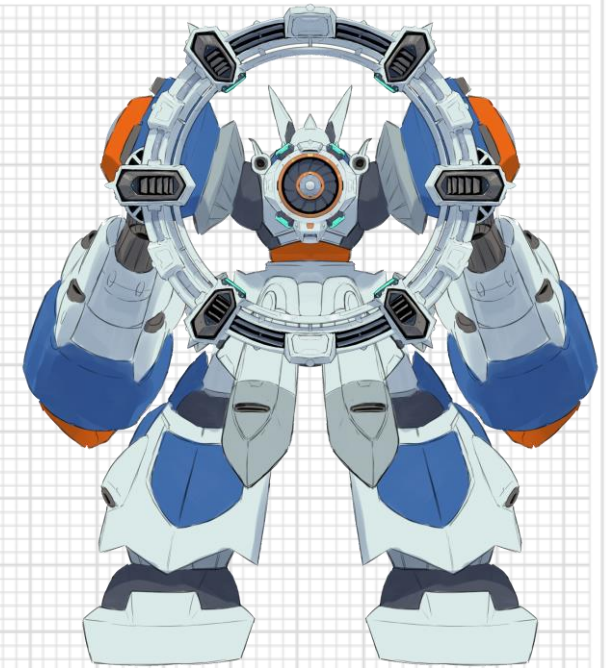
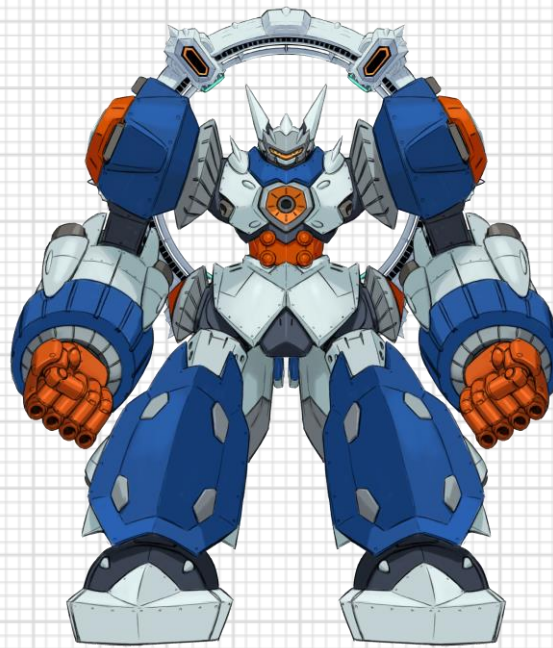
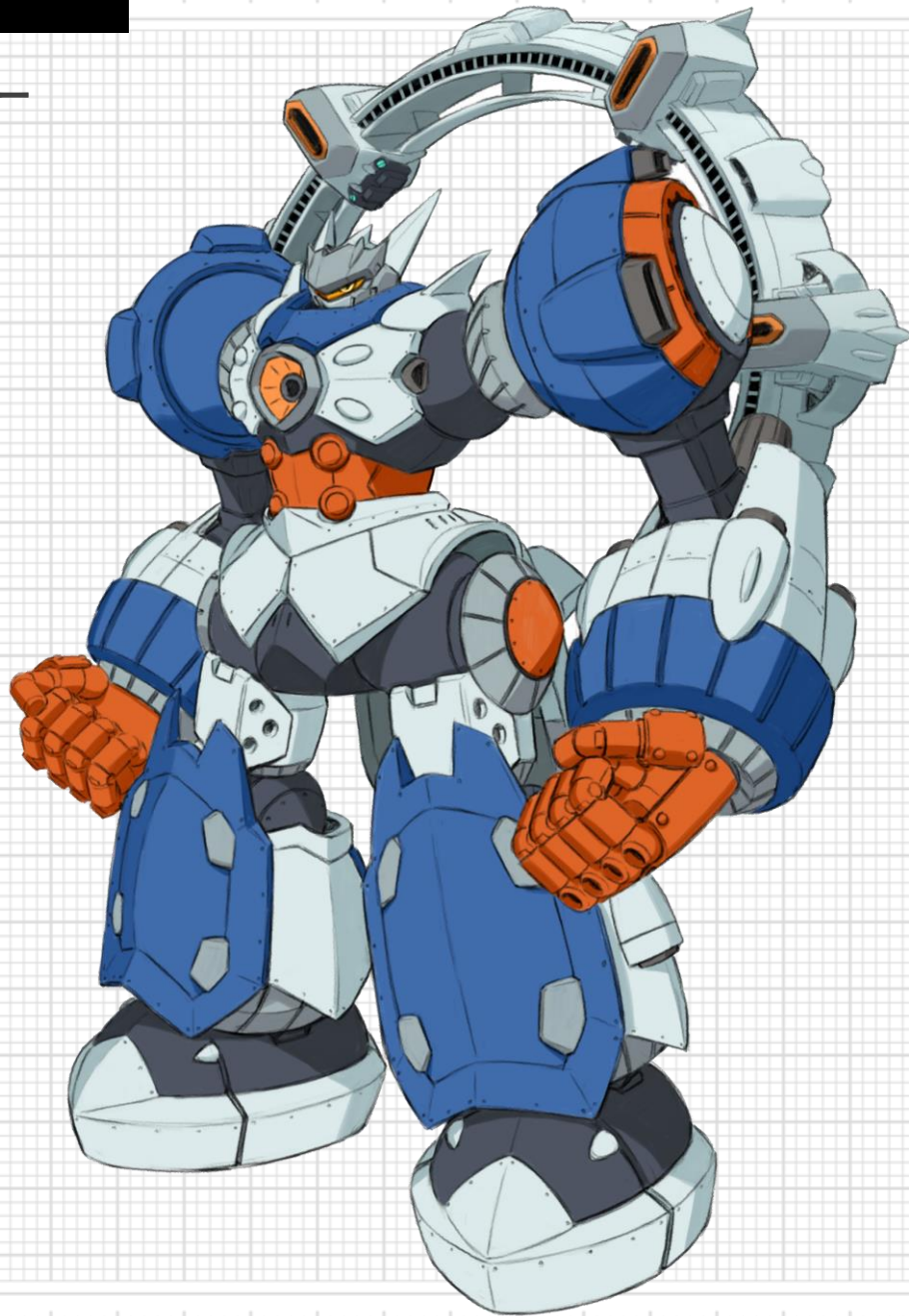



■アーサーライザー

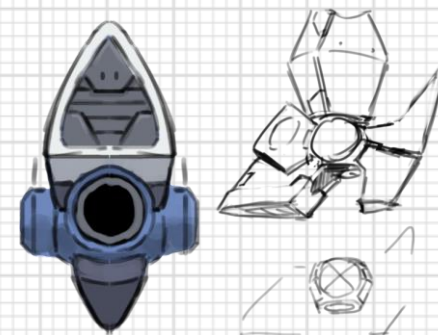
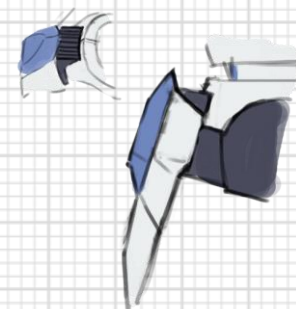
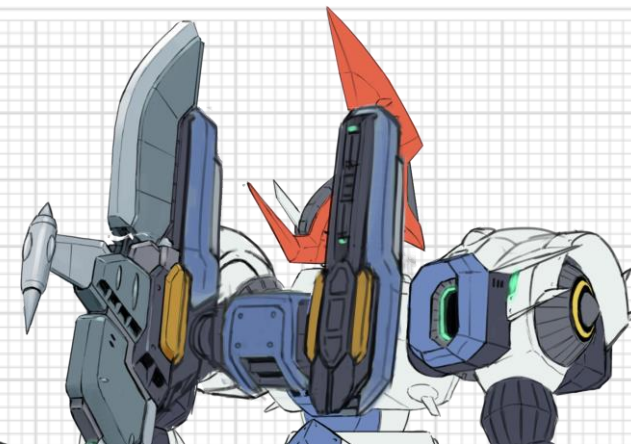
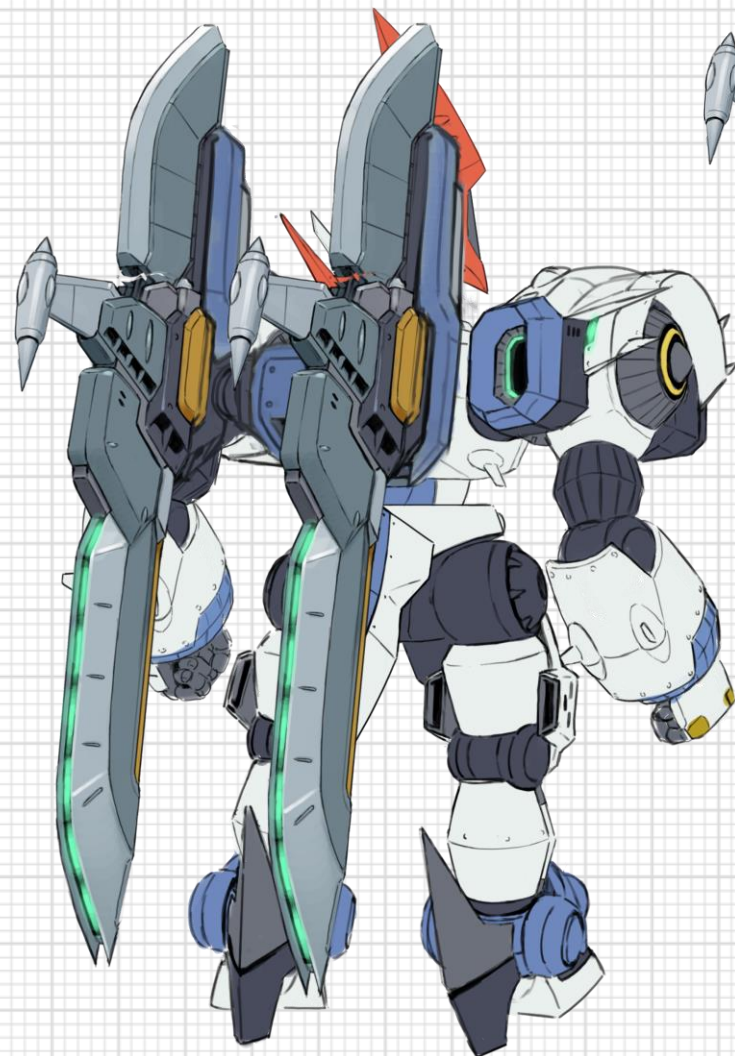
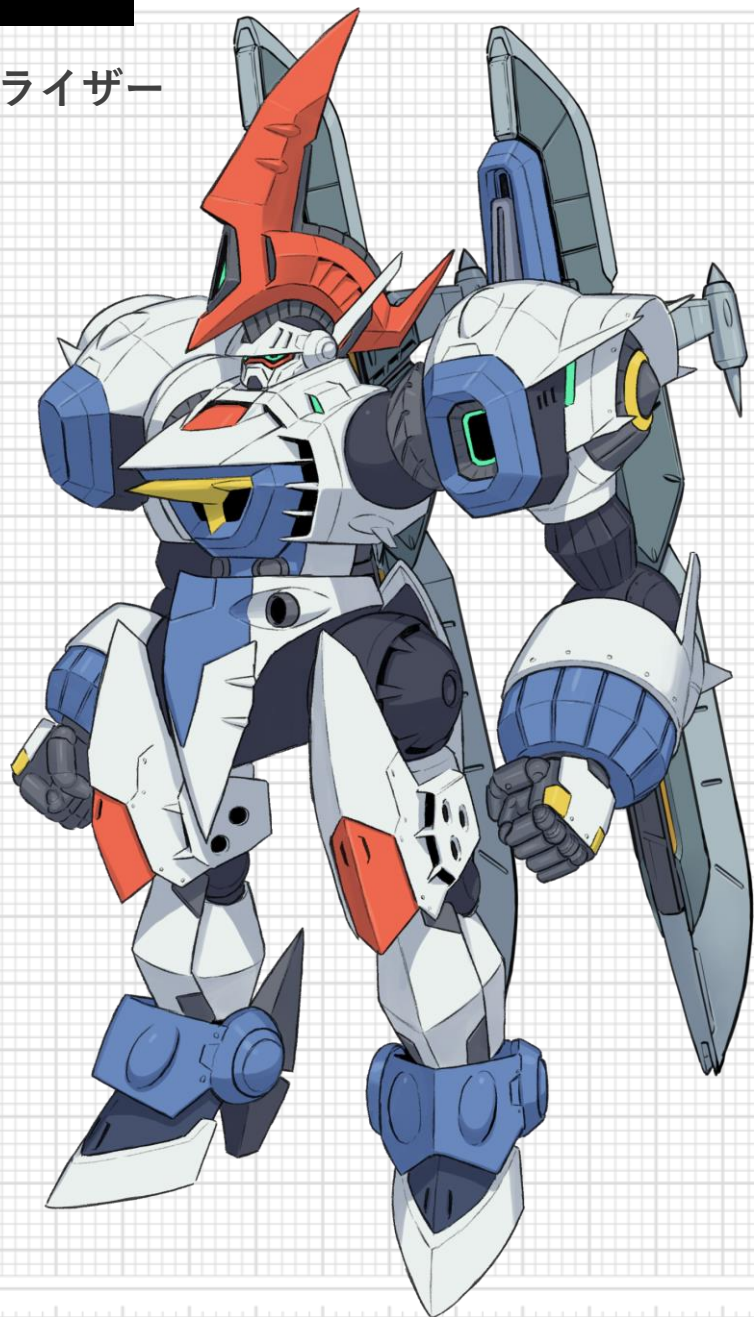



■ マキシマスブレイズ

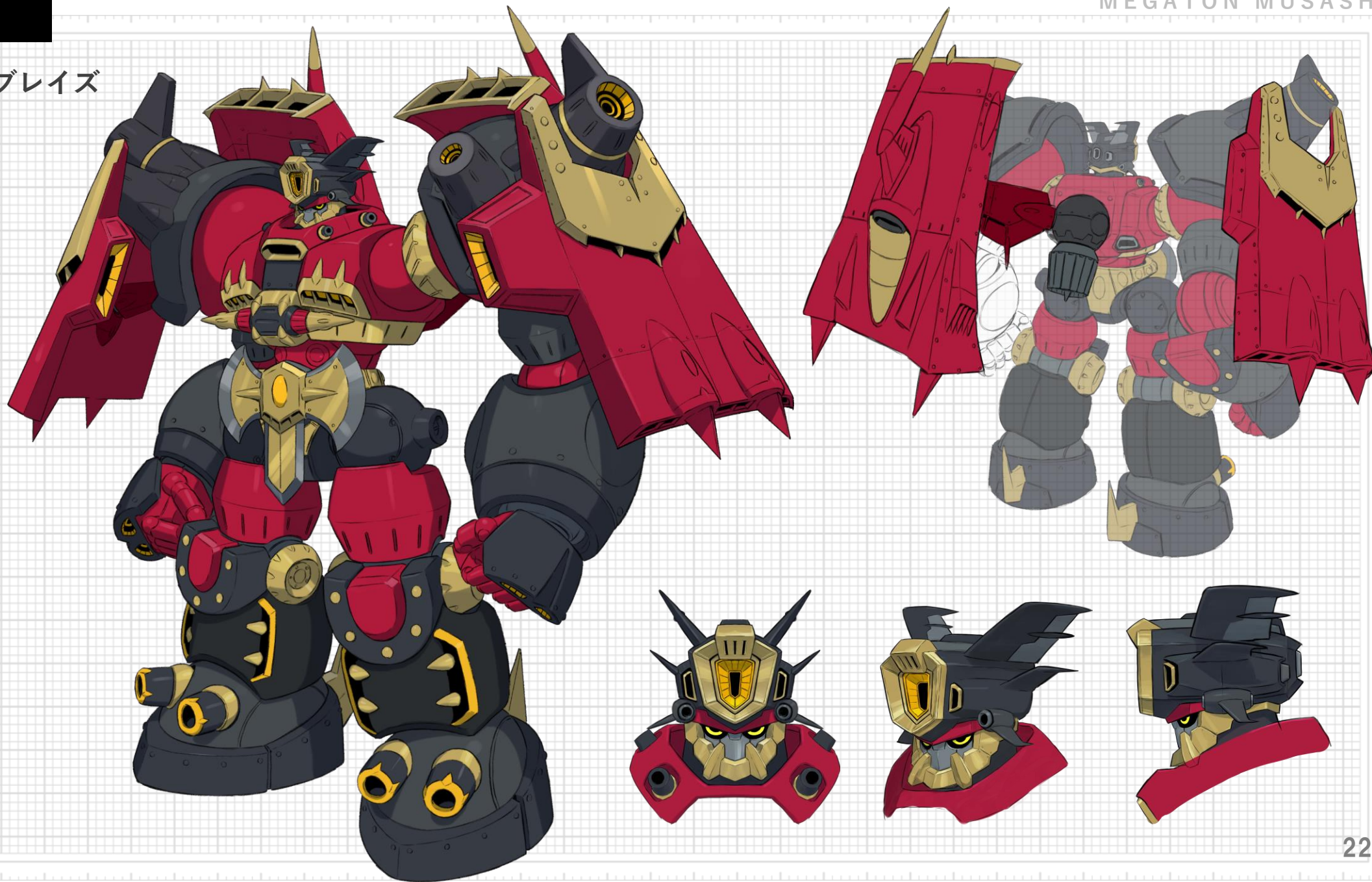



■ スパークマンウェイブ

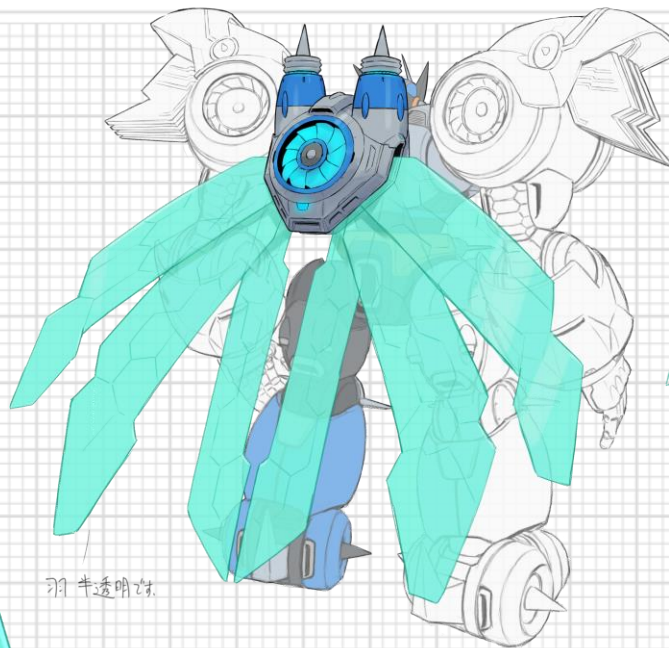
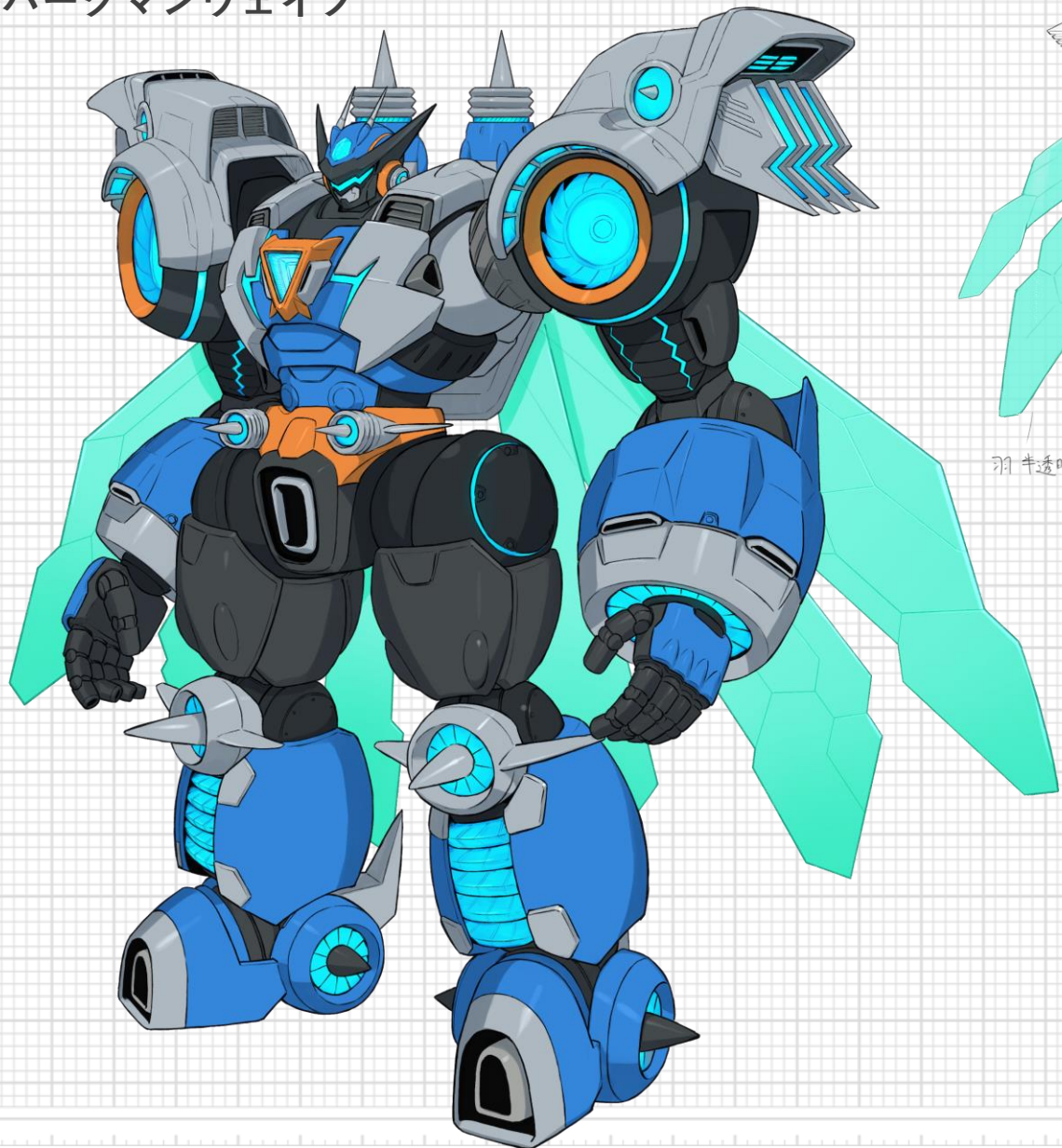

羽半透明時

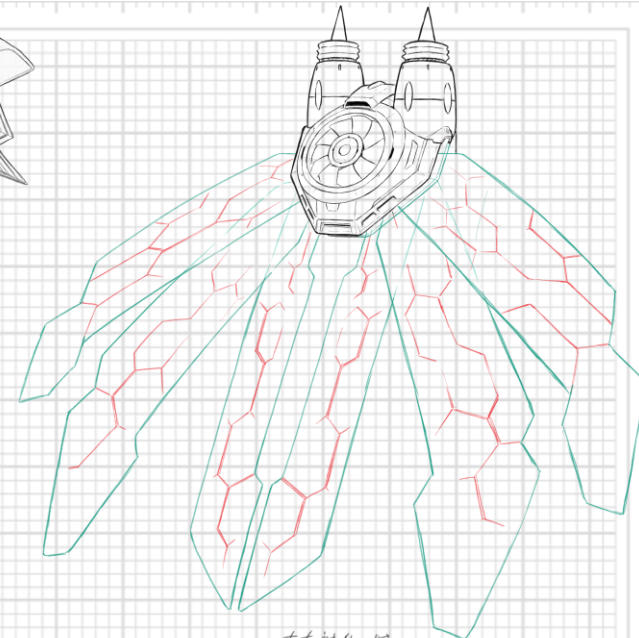

左右対称で可。

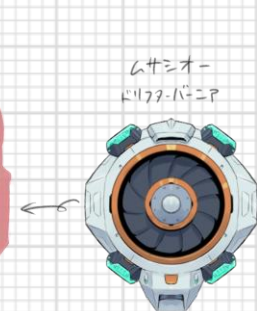
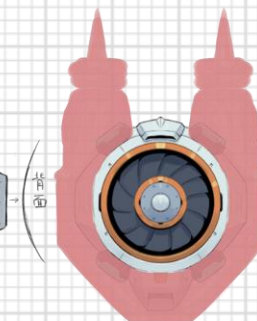
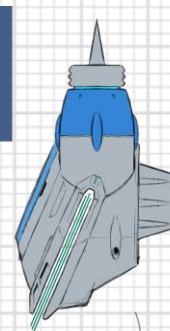

ムサシオー  
ビルダーバニャ

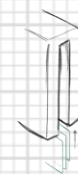

羽側面



■ ガウディアアーマード

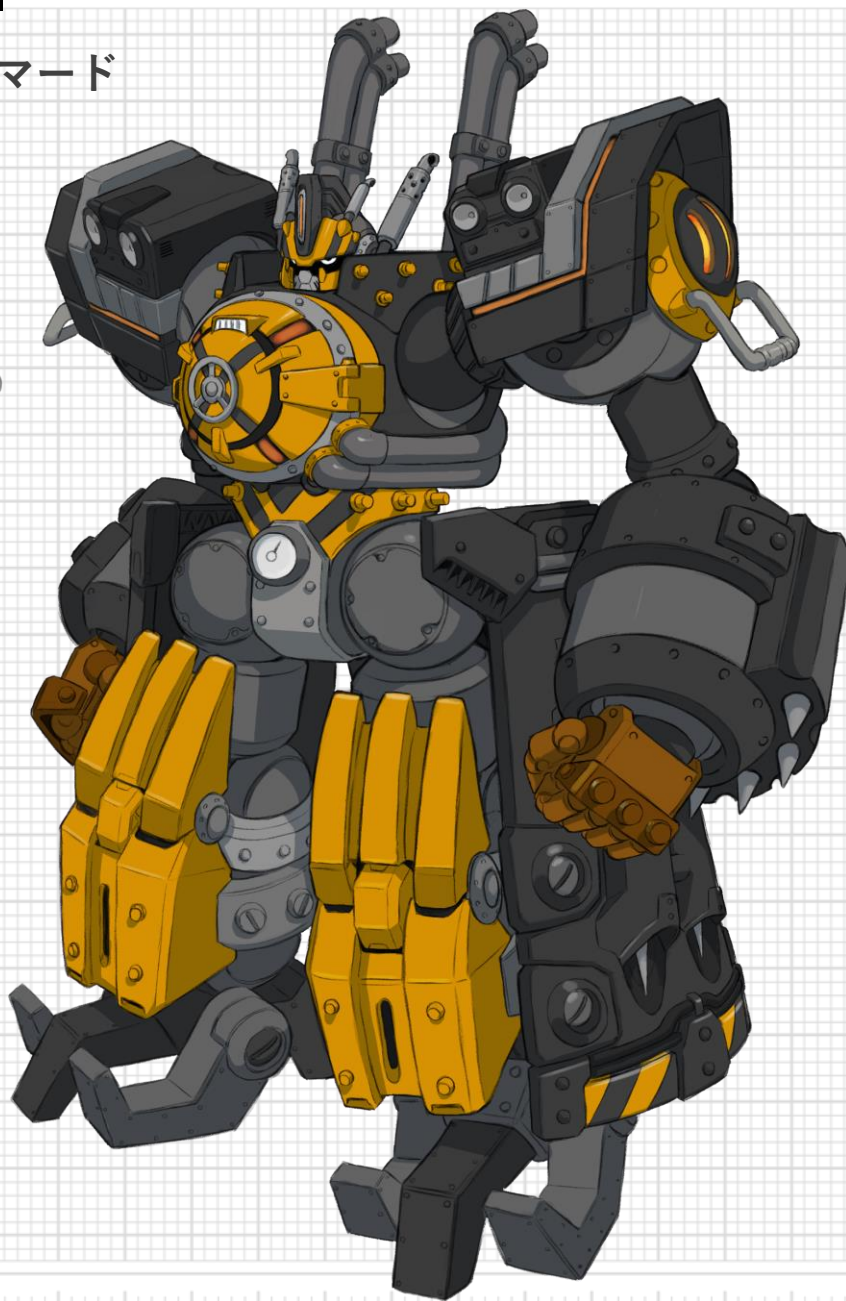
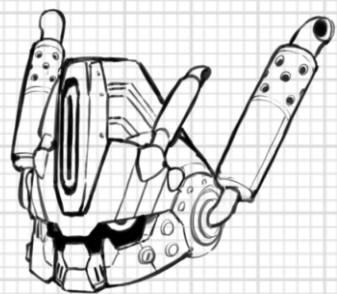

ガウディア ヒールズ

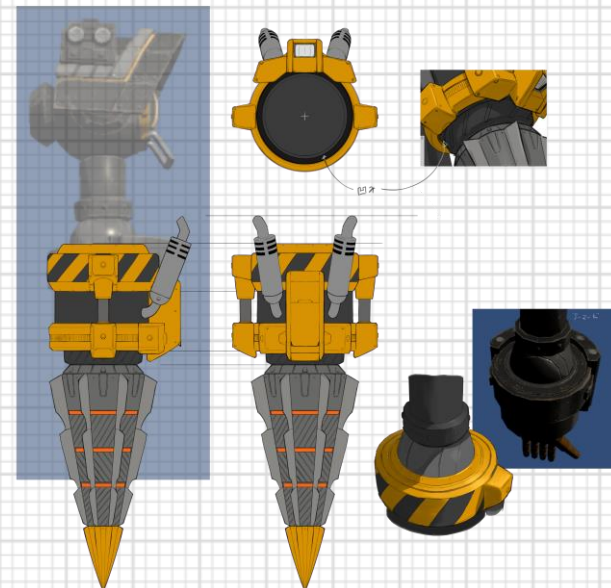
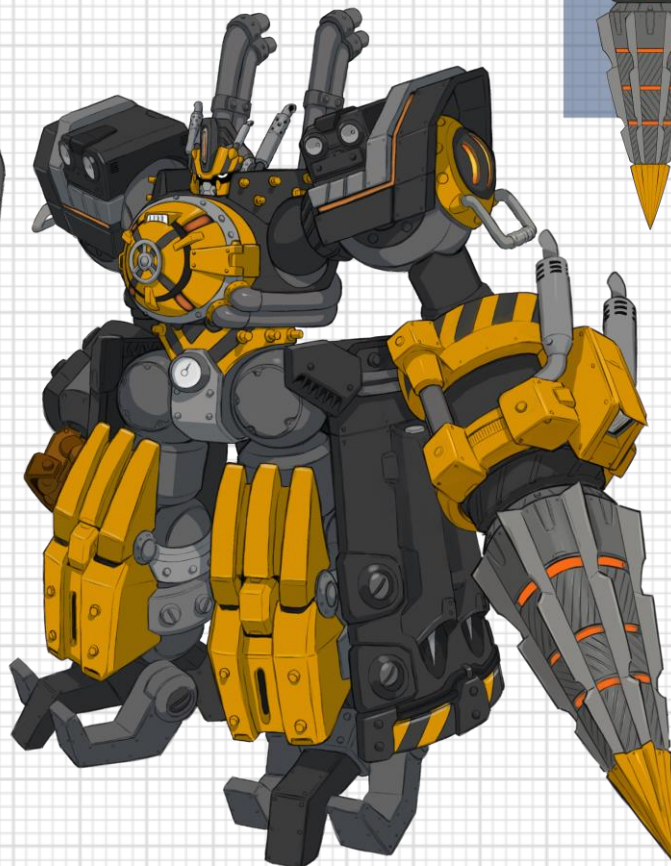



■ マウンターポリス

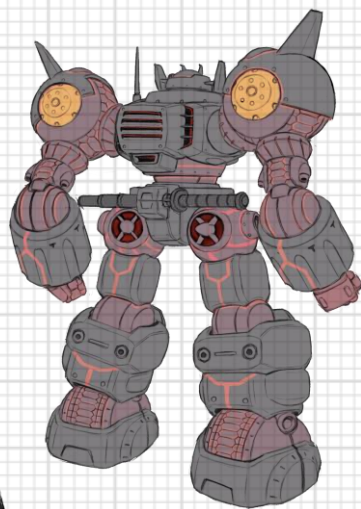
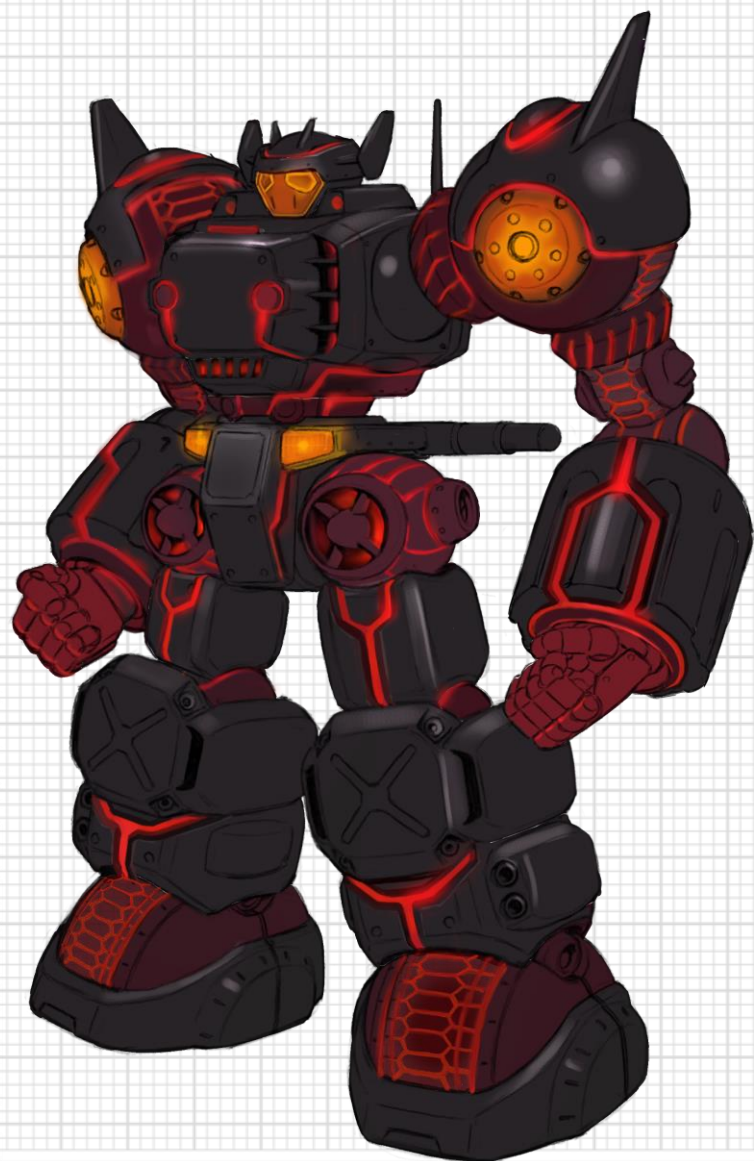

■ マウンターソルジャー

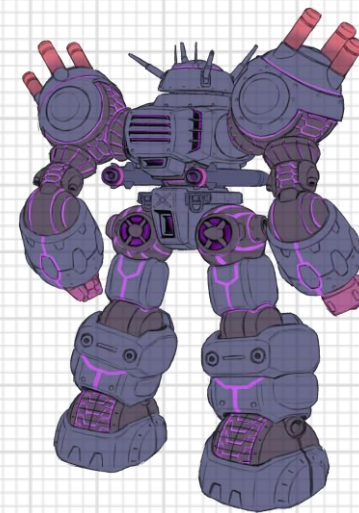
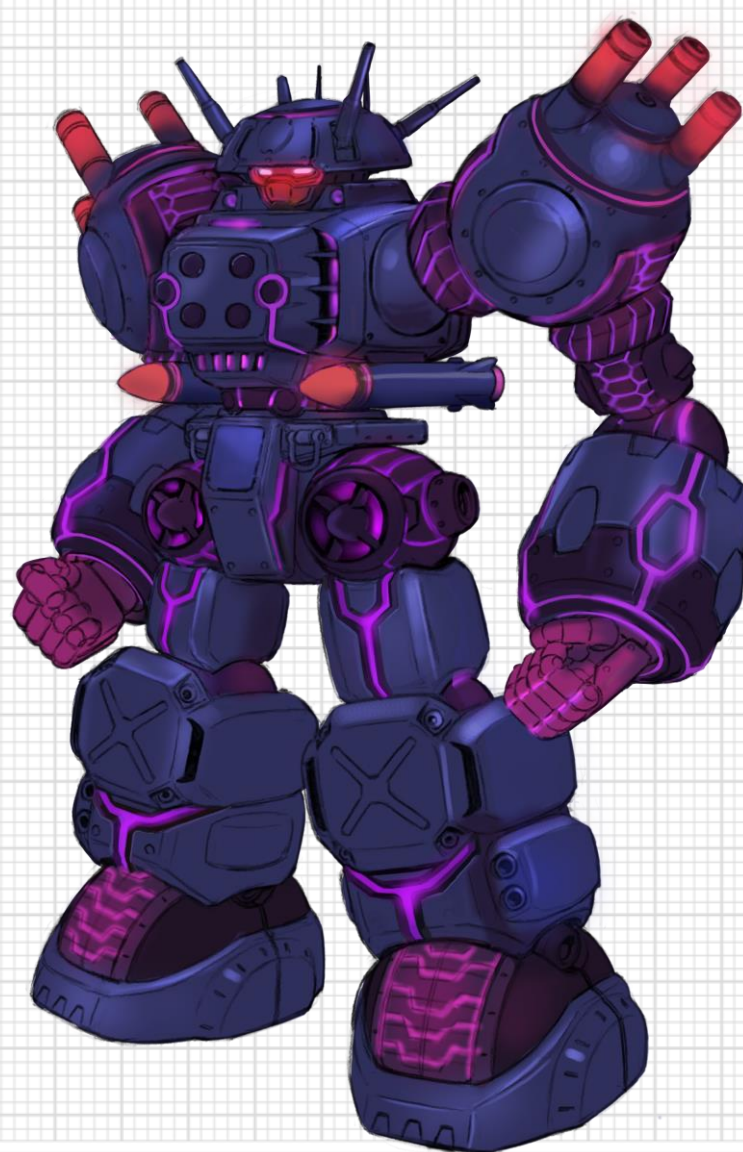



**ENEMIES**

■ ホッパー

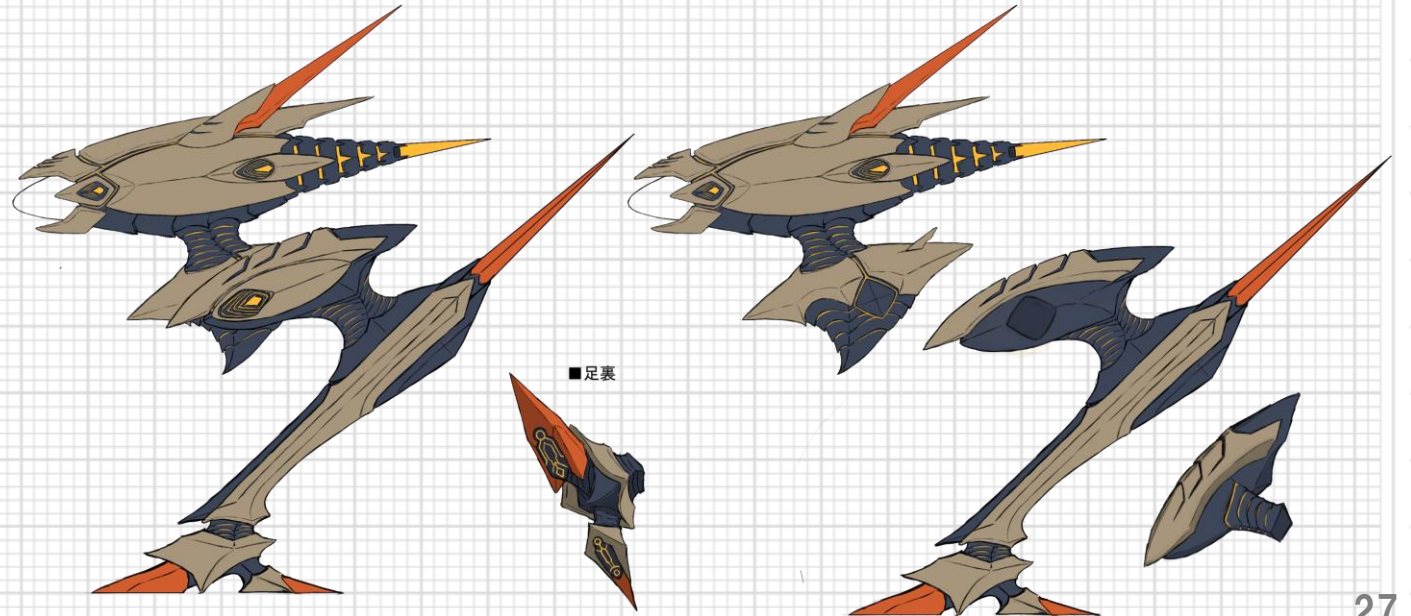
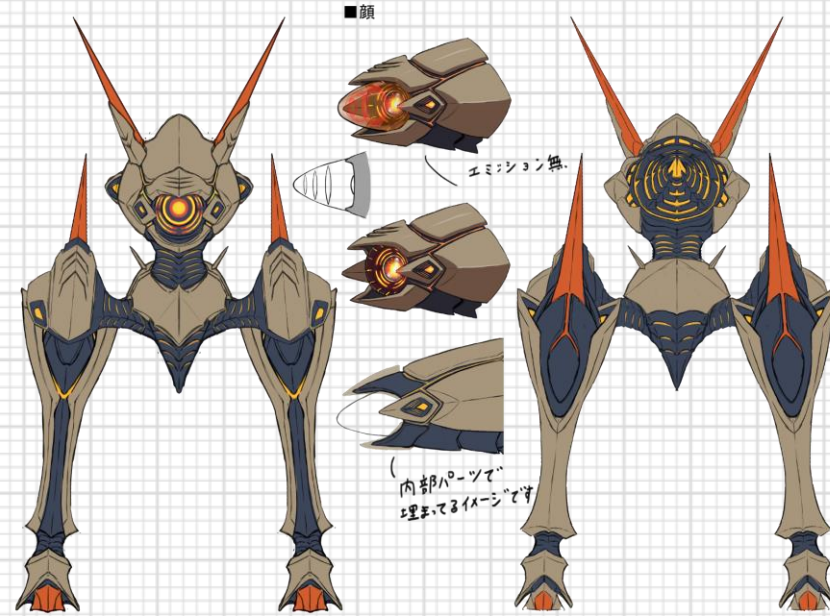
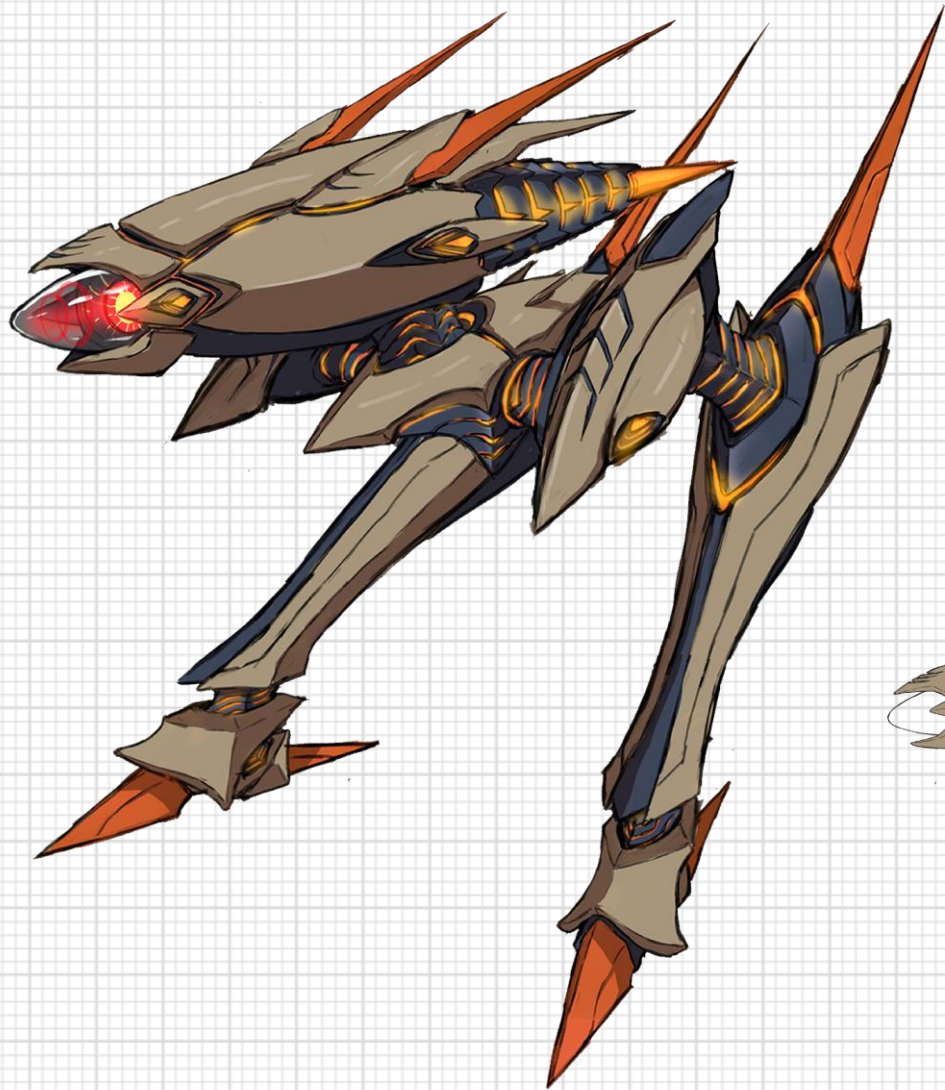



## ■モグラ



## ■ ディーファルグ M-Type

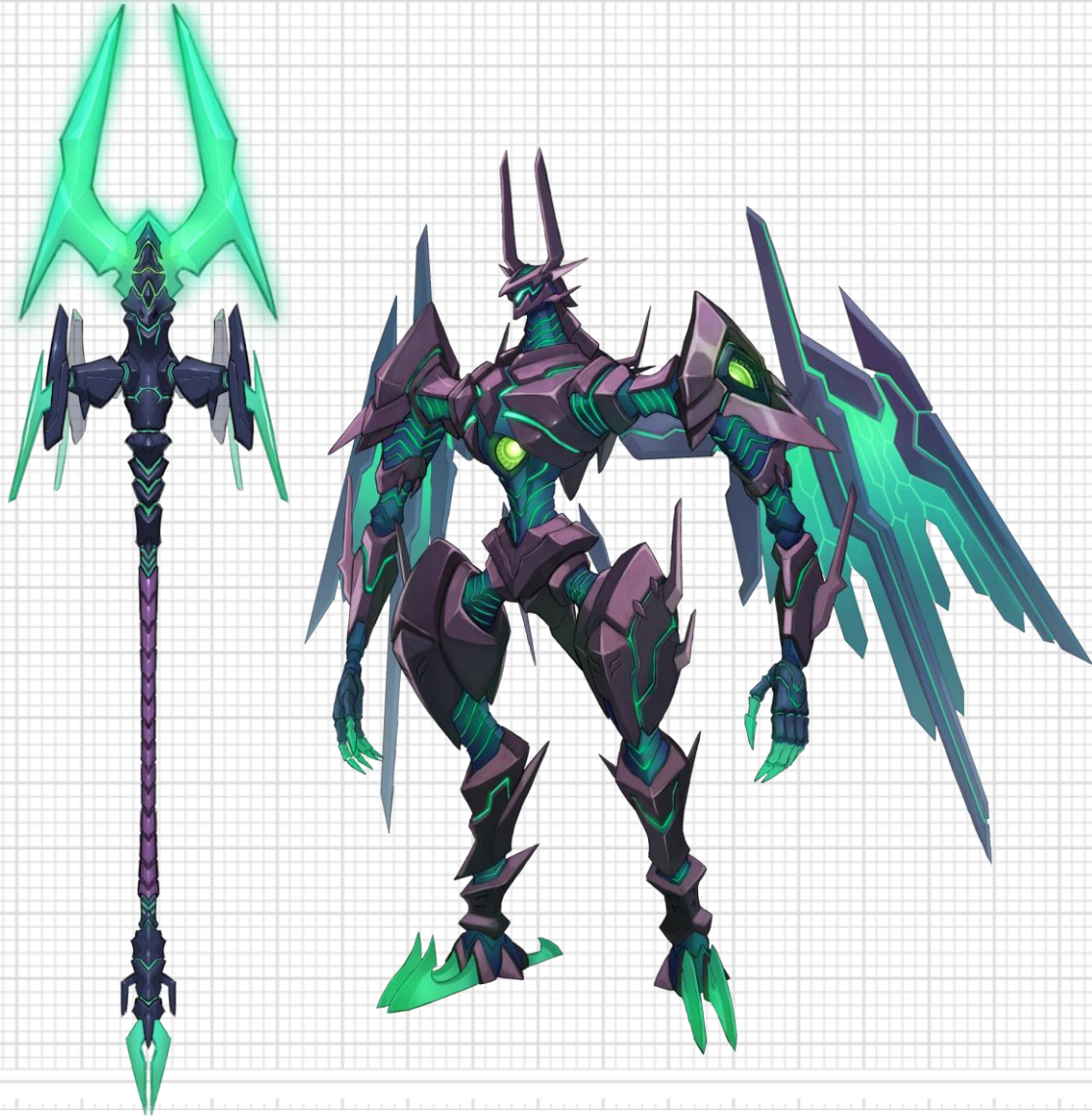

## ■ ディーファルグ Y-Type





■バルログ

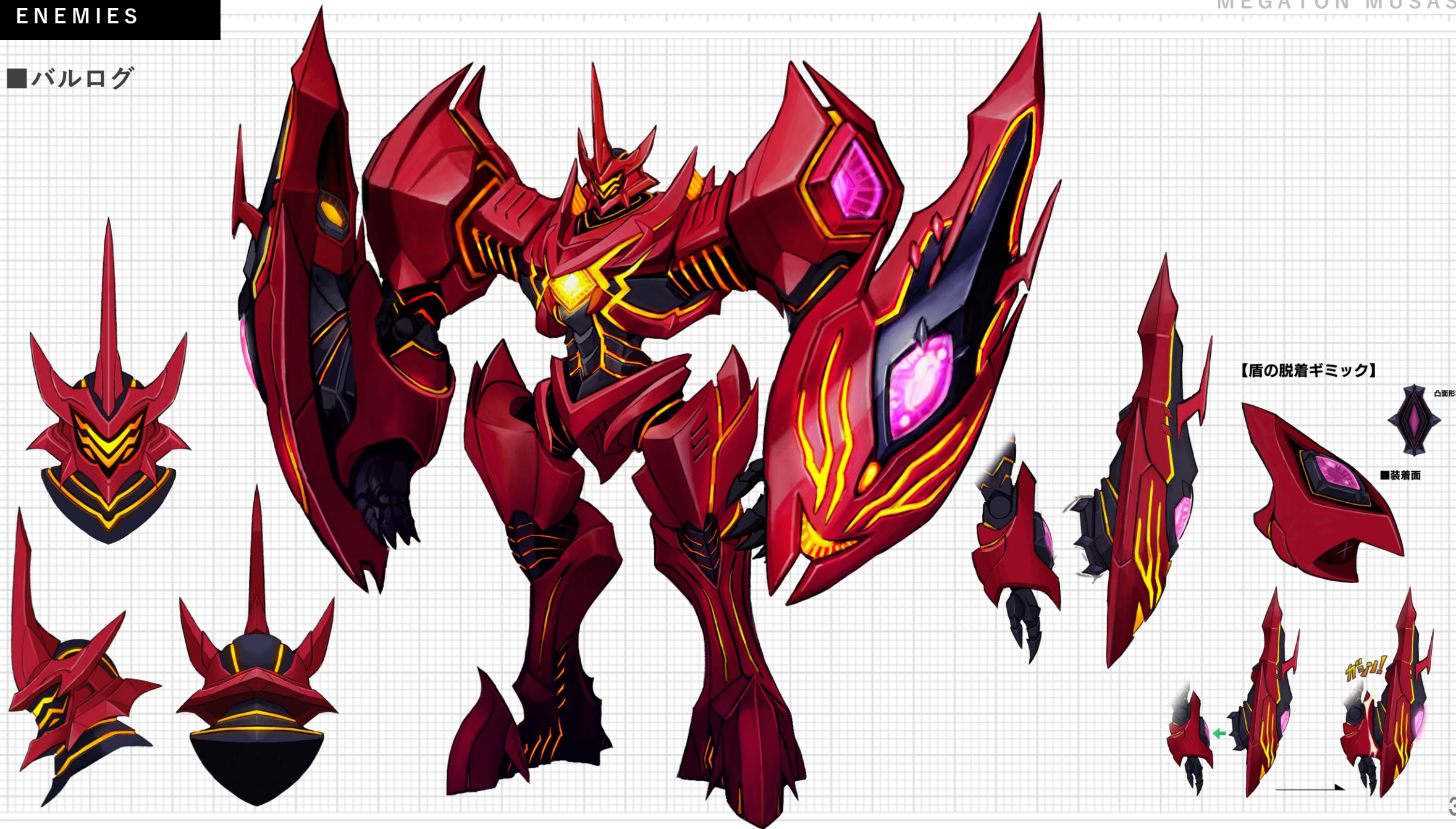



■ビッグタンクコマンダー

■副砲

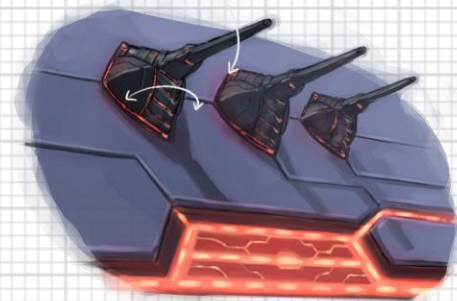
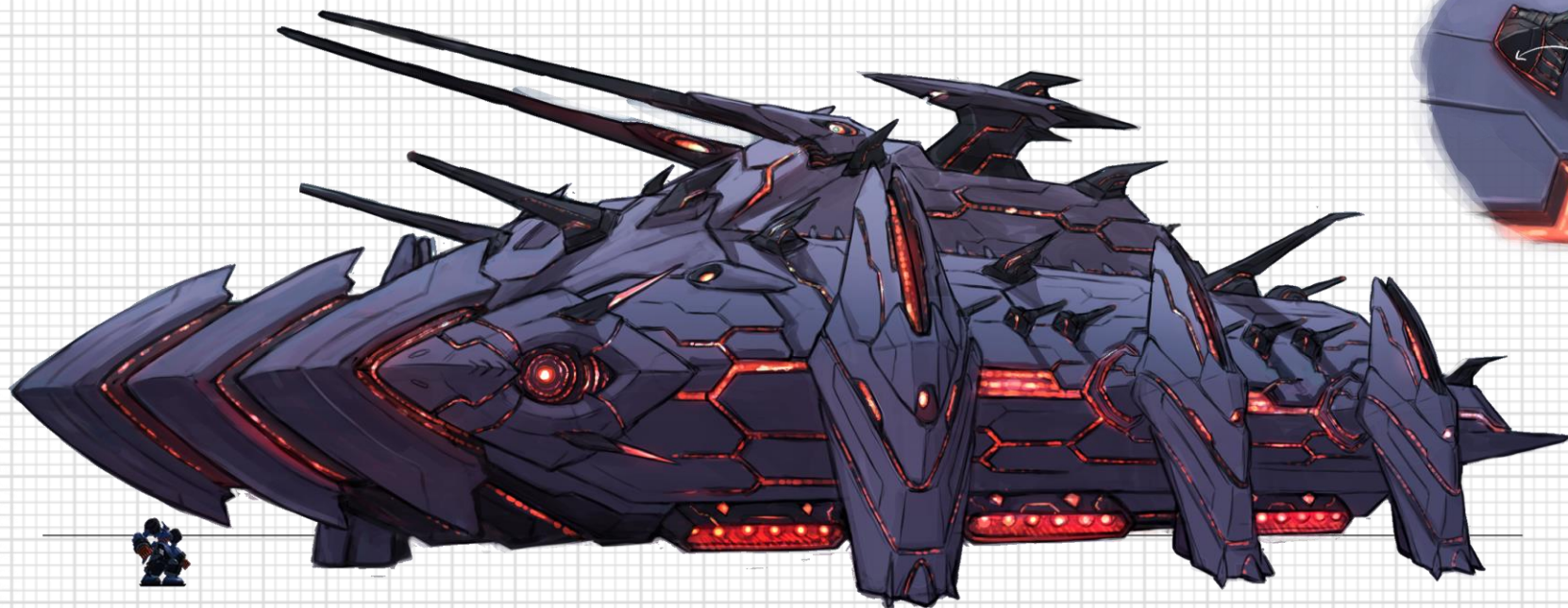

発光アニメーション方向



ビッグタンク. ブリッジ(コックピット)ラフ

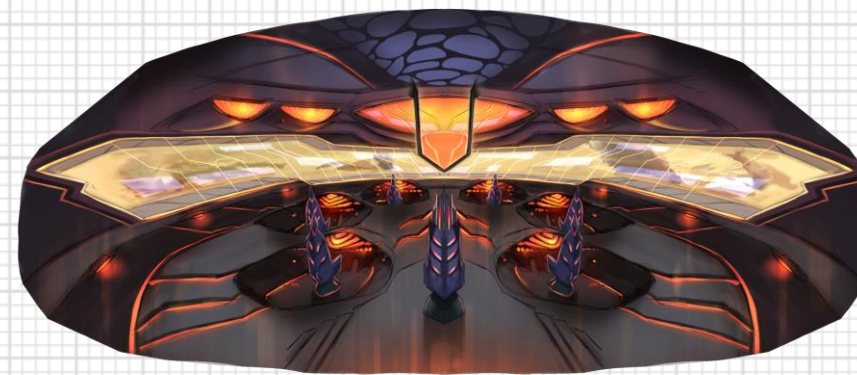
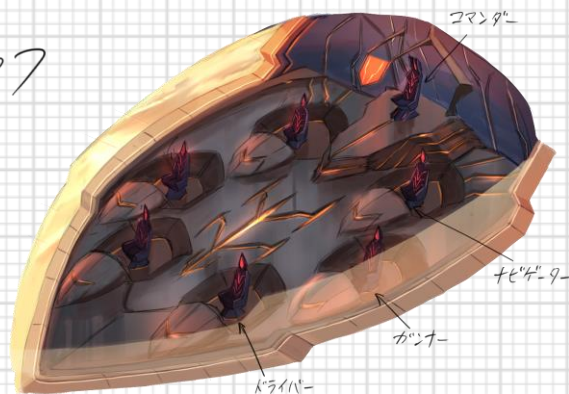
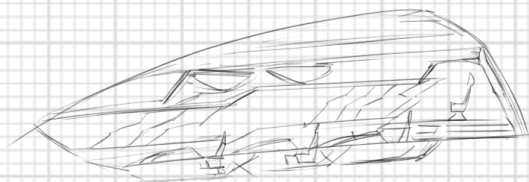



■ウォーカー

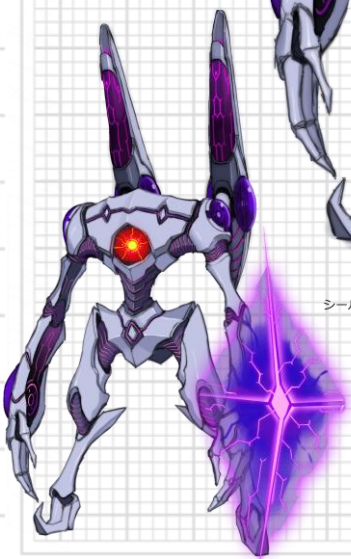
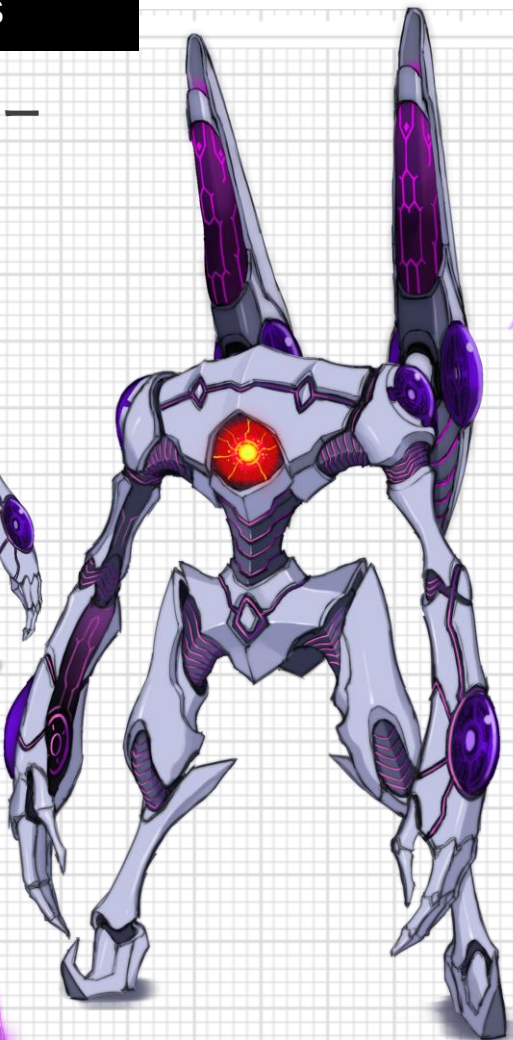
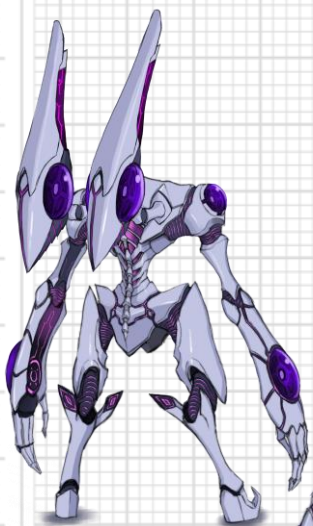

シールド

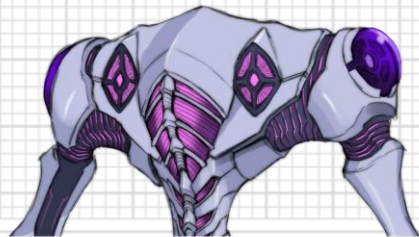

後面部の背中



普通出力



最大出力

クローの形

普段の出力を出せば

クロー形の武器で変換可能です。

剣の形

最大の出力を出せば

剣の形の武器になります。

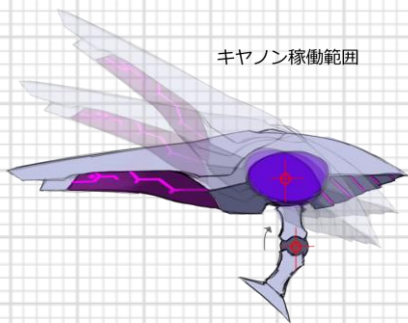

キヤノン稼働範囲

赤く表示された関節を軸に回転します。

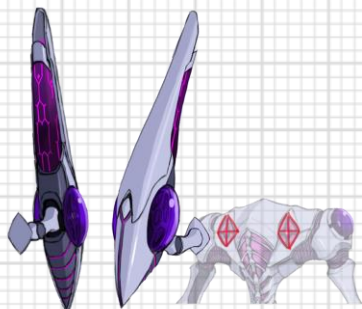

背中に赤く表示された部分に  
キヤノンを装備します。



ドラクエ  
バグロット



足裏

ソックス×70(各足)  
複製でいいから

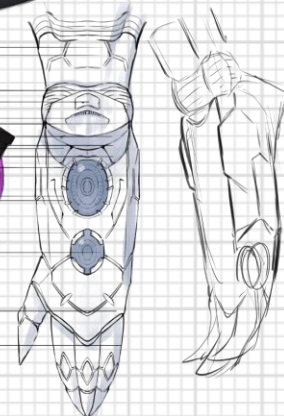
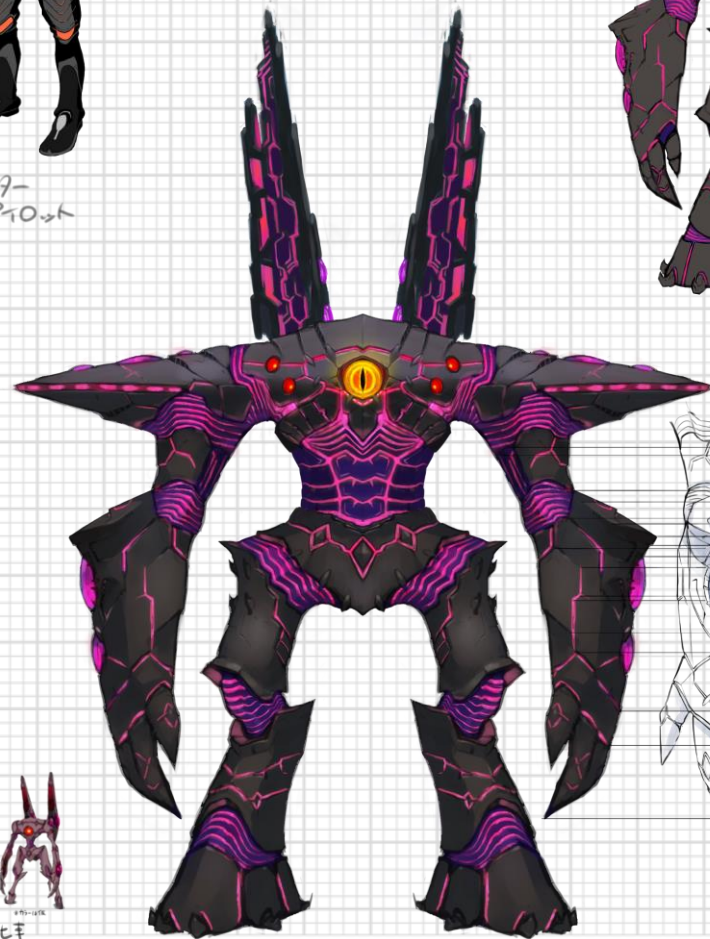
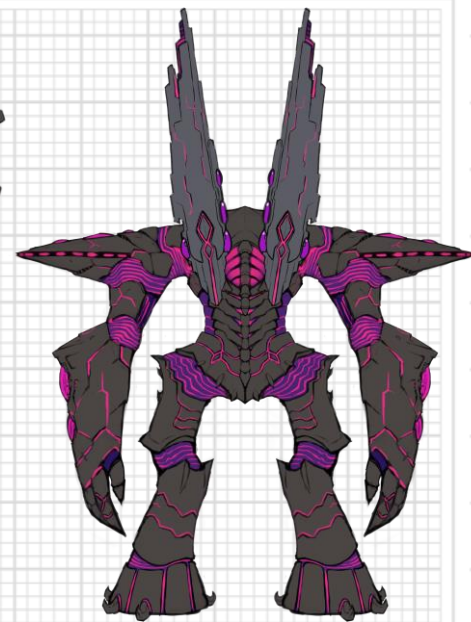

スケルビキ



## ■ ホーン

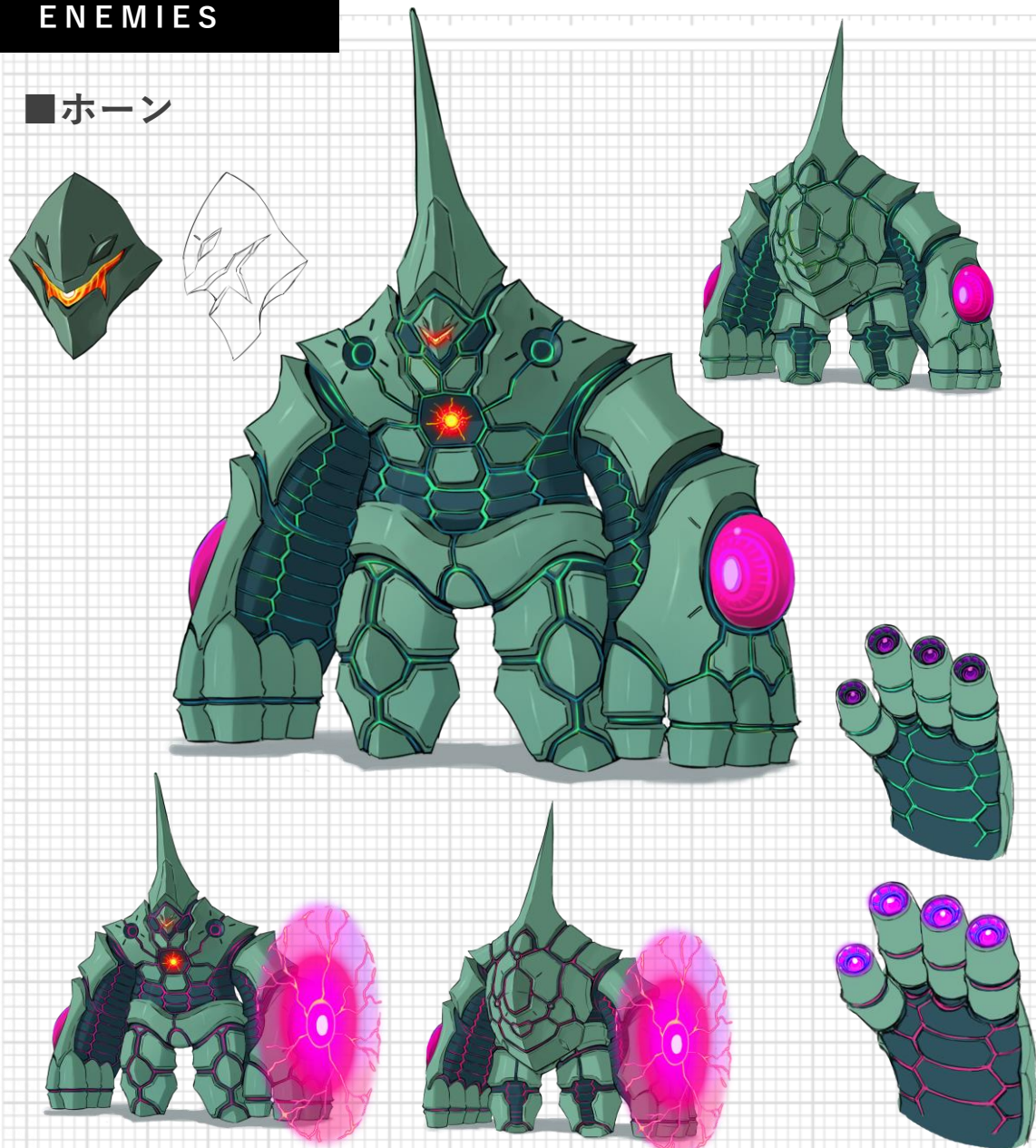

エフェクト発生時に血管の色が緑色からピンク色に変わります。

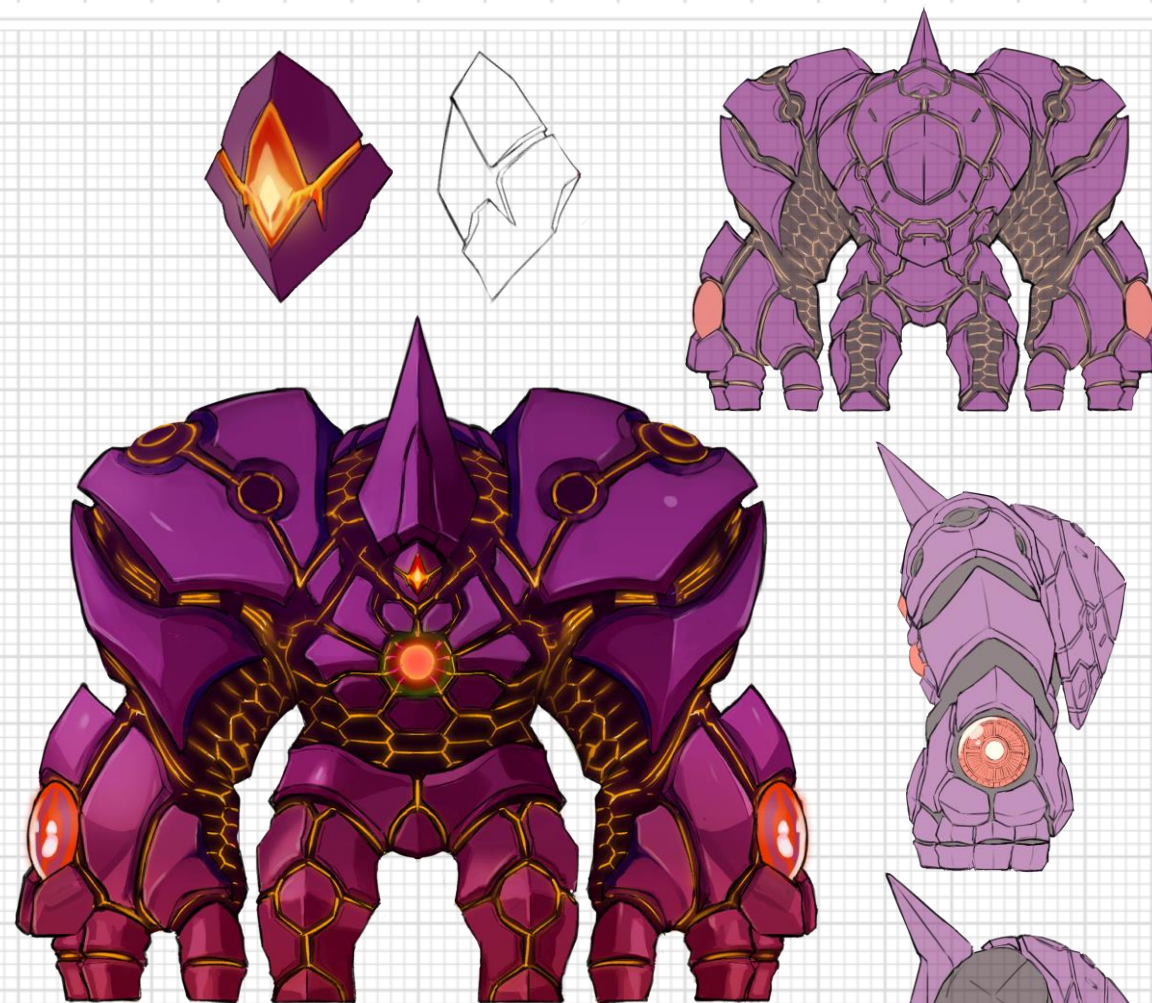

## ■ 足裏

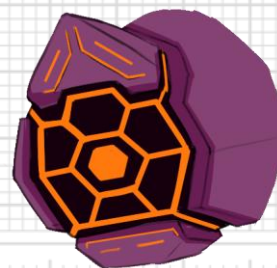



## ■ クラブ



地面に隠れていて、自爆したり、ターゲットに素早く近付いて自爆します

地雷を放出する時の血管と内部が発光します。

**WORLD**



## ■イクシア シェルターゲート入口



■音響記憶操作装置

音響記憶操作装置

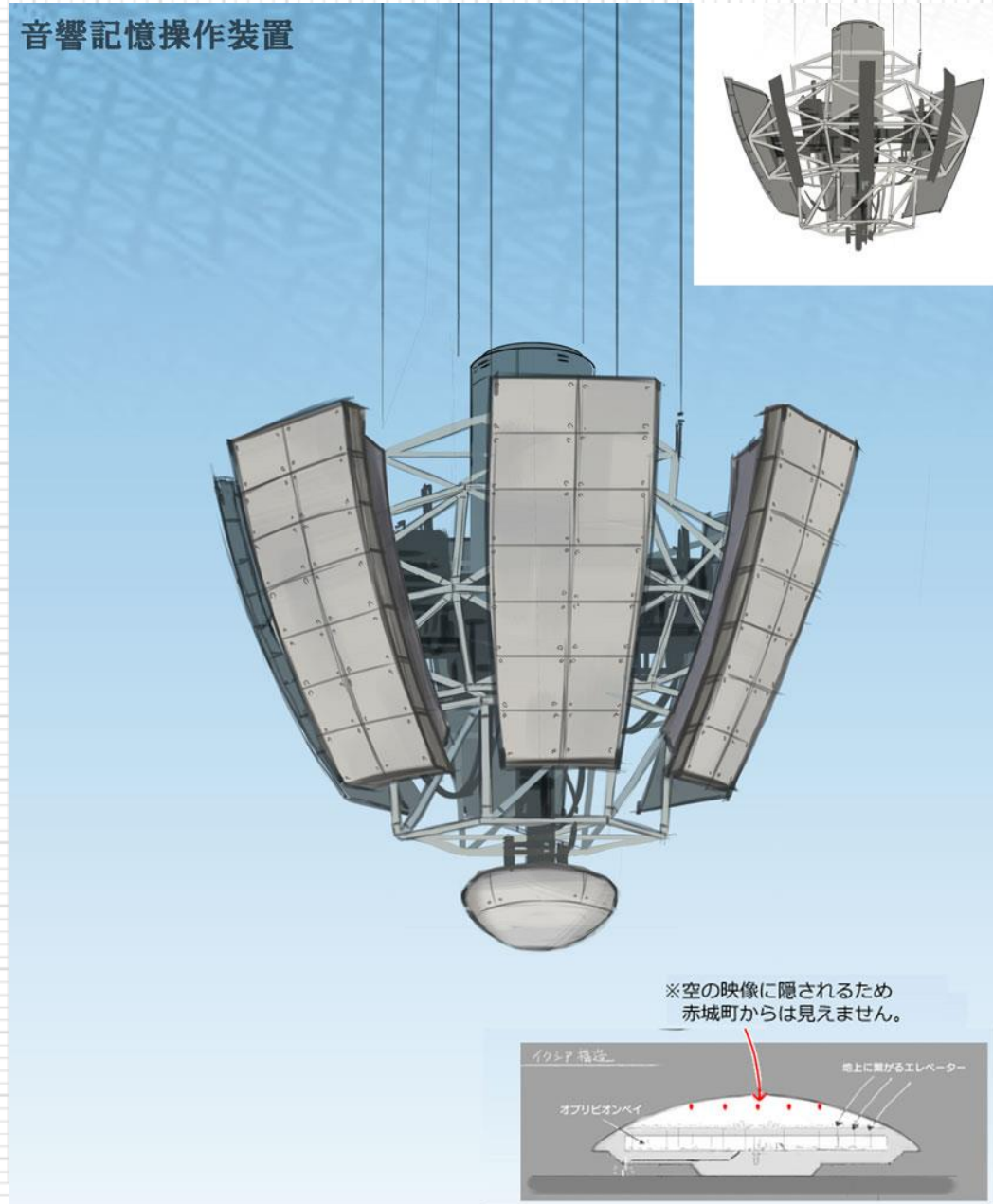



## ■シドルゴア グリファース自室



## ■シドルゴア 通路





■要塞ゴッドハンマー





## ■要塞ゴッドハンマー





## ■要塞ゴッドハンマー





## ■要塞ゴッドハンマー タワー

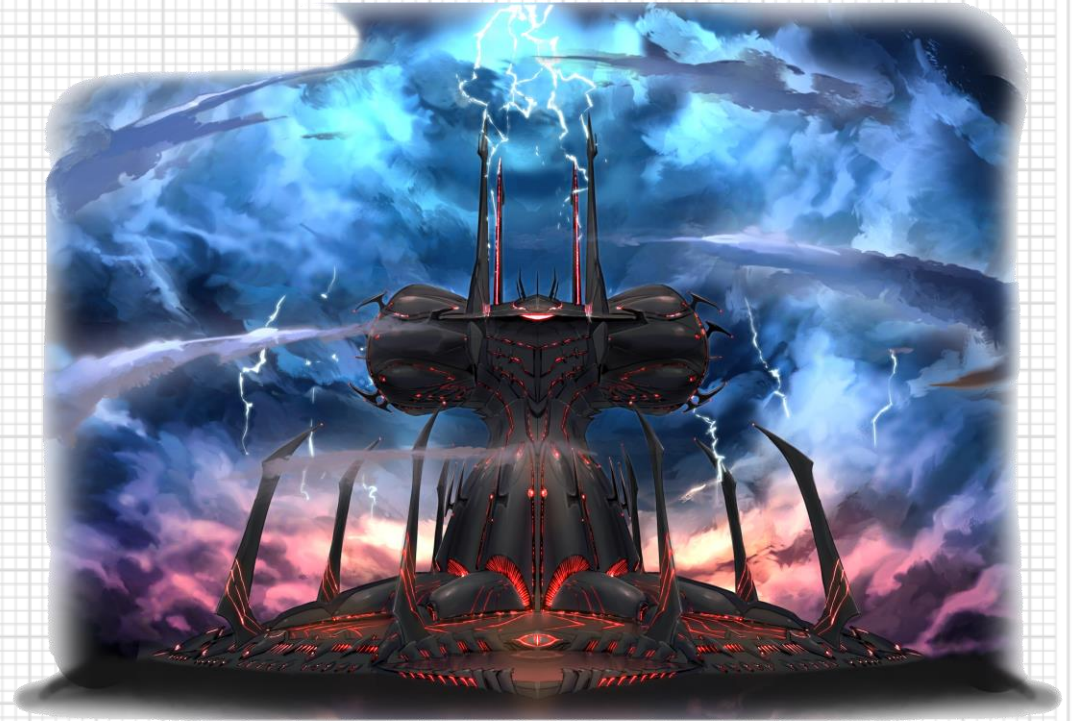



■要塞ゴッドハンマー 出撃デッキ

出撃デッキ

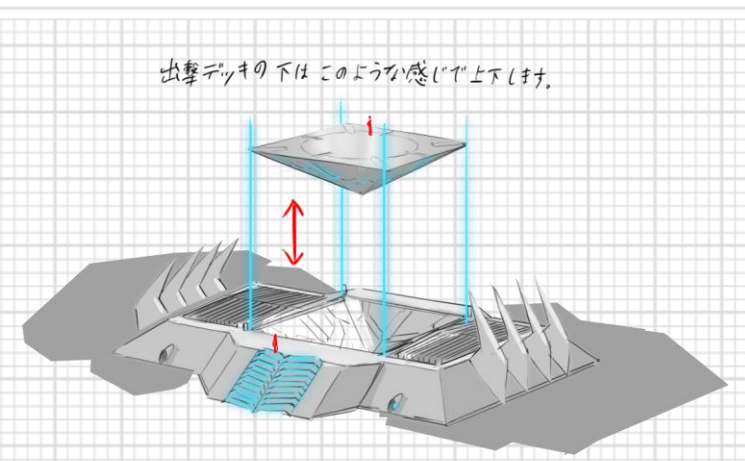
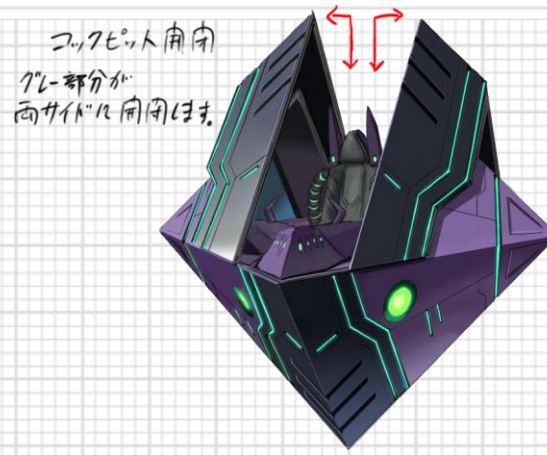
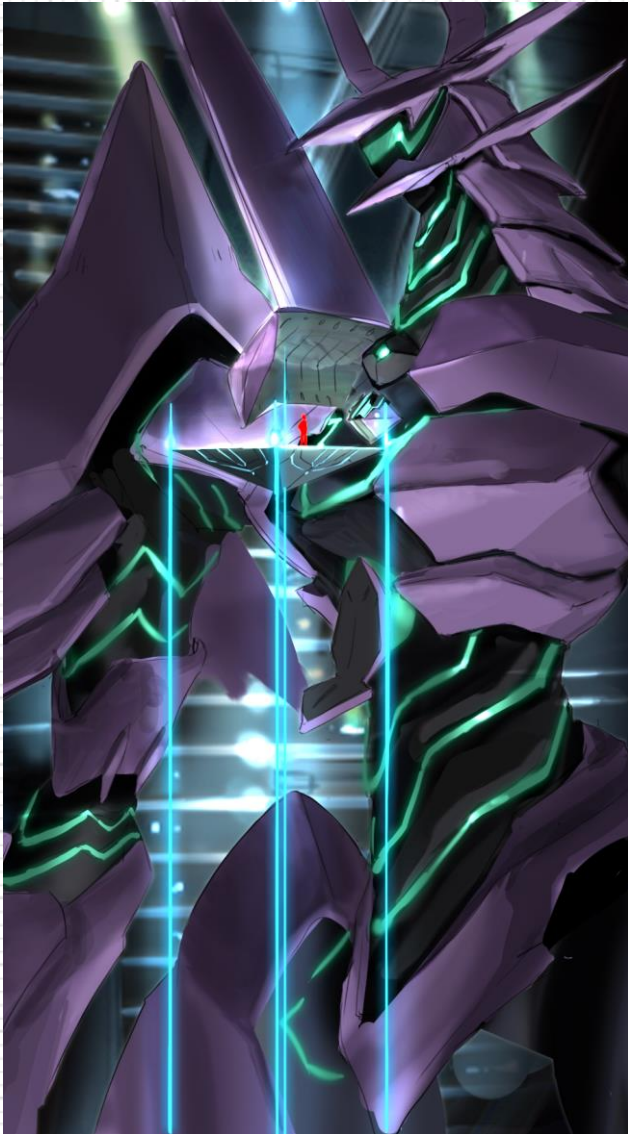



## ■ ソロン 大通り





## ■ ソロン 高台





## ■ ソロン 広場





## ■ ソロン ログ格納庫



## ■ ソロン 水汲み場





■ ソロン

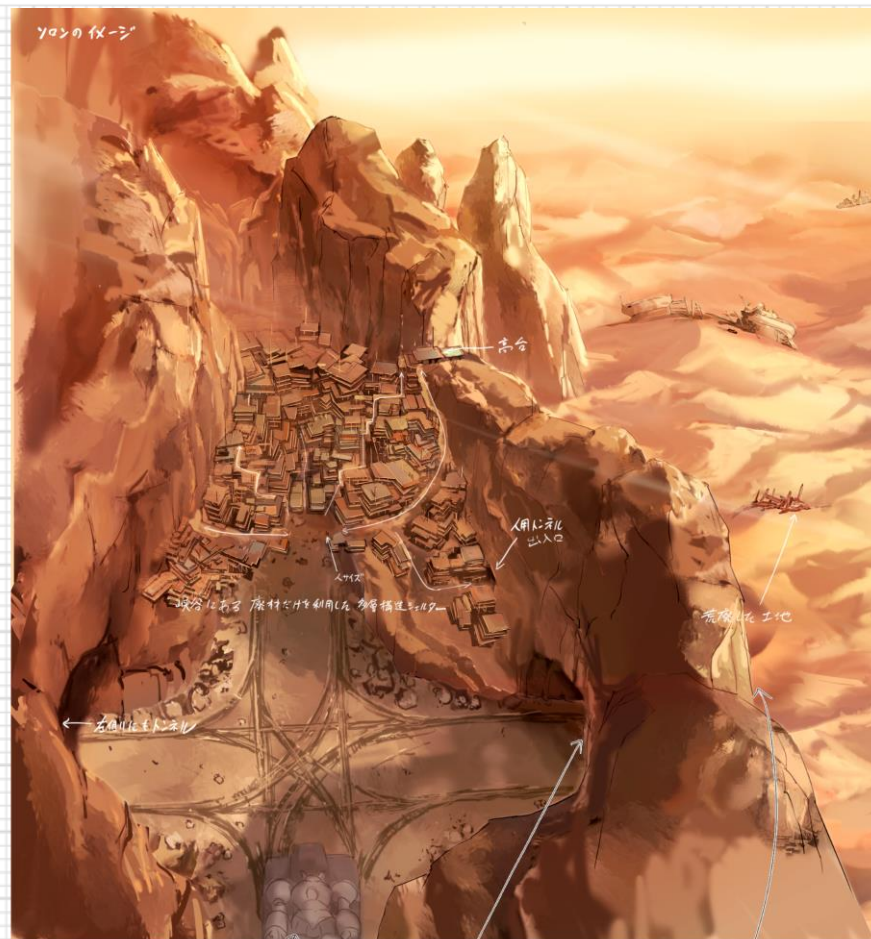

裏側は 収納可能なように  
扉は穴をあけています

トンネルの裏側で  
扉は扉が閉じます

トンネルの裏側は 岩肌は偽装して見せ

人用トンネル  
出入口

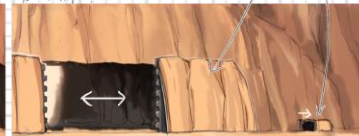
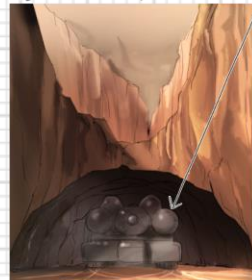

■ ソロン 食料貯蔵庫



ソロン 食料貯蔵庫



00号-00号の扉は! 2枚の扉は...





## ■ ソロン 大気浄化装置

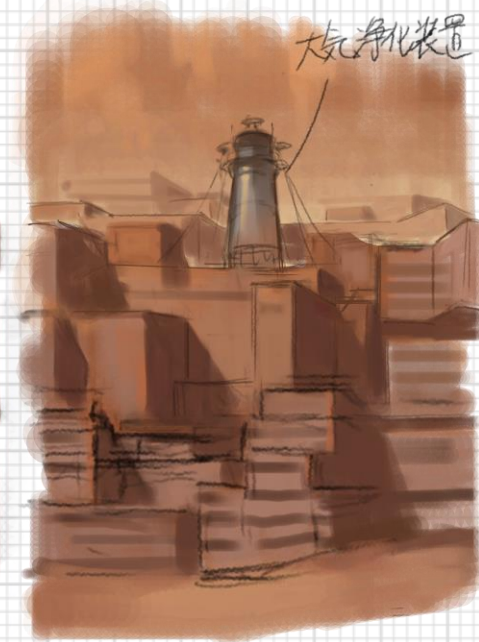



■ ソロン 居住区



居住区  
北大イキ-ジ

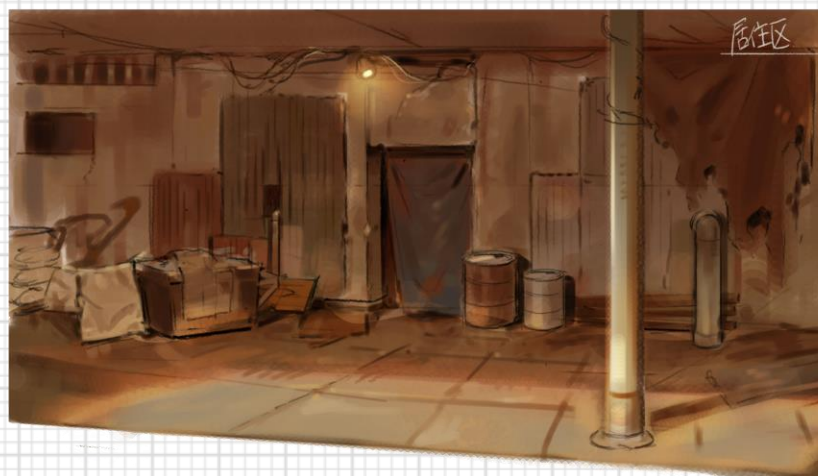



■ ソロン ヴィクトの家 内観



切り返し



1F

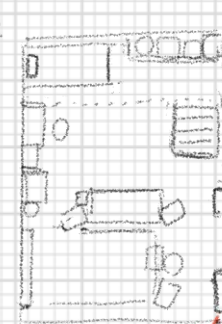

M2F

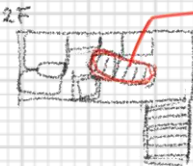

寝袋

入口

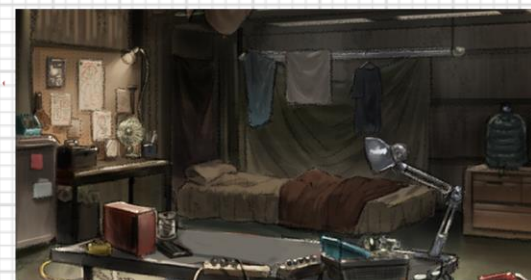

Lベッド詳細



■ ソロン 民家 内観

民家 / 内観 (屋) リウの家

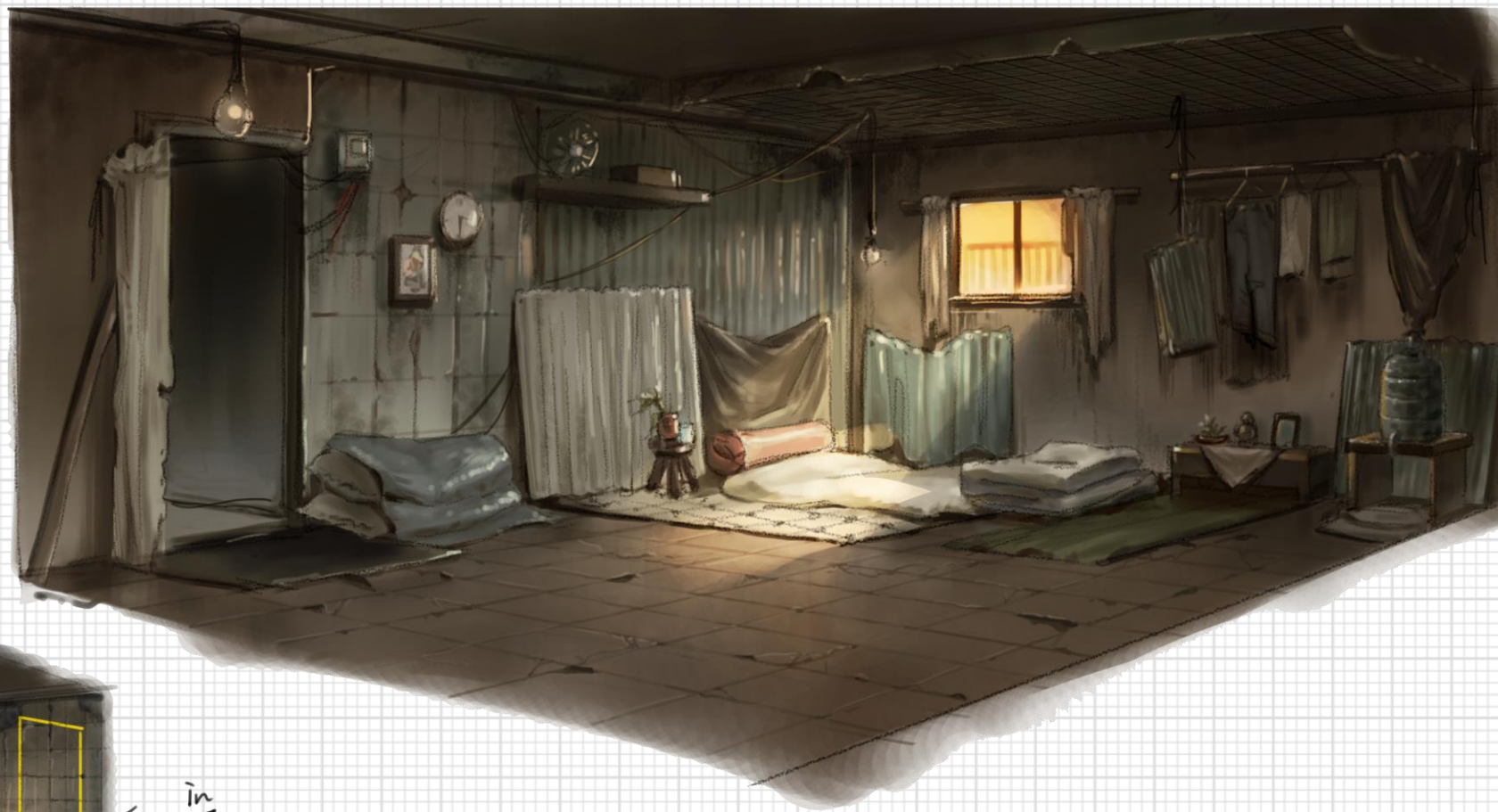

in ←

切り返し



## ■ ソロン 民家 内観

























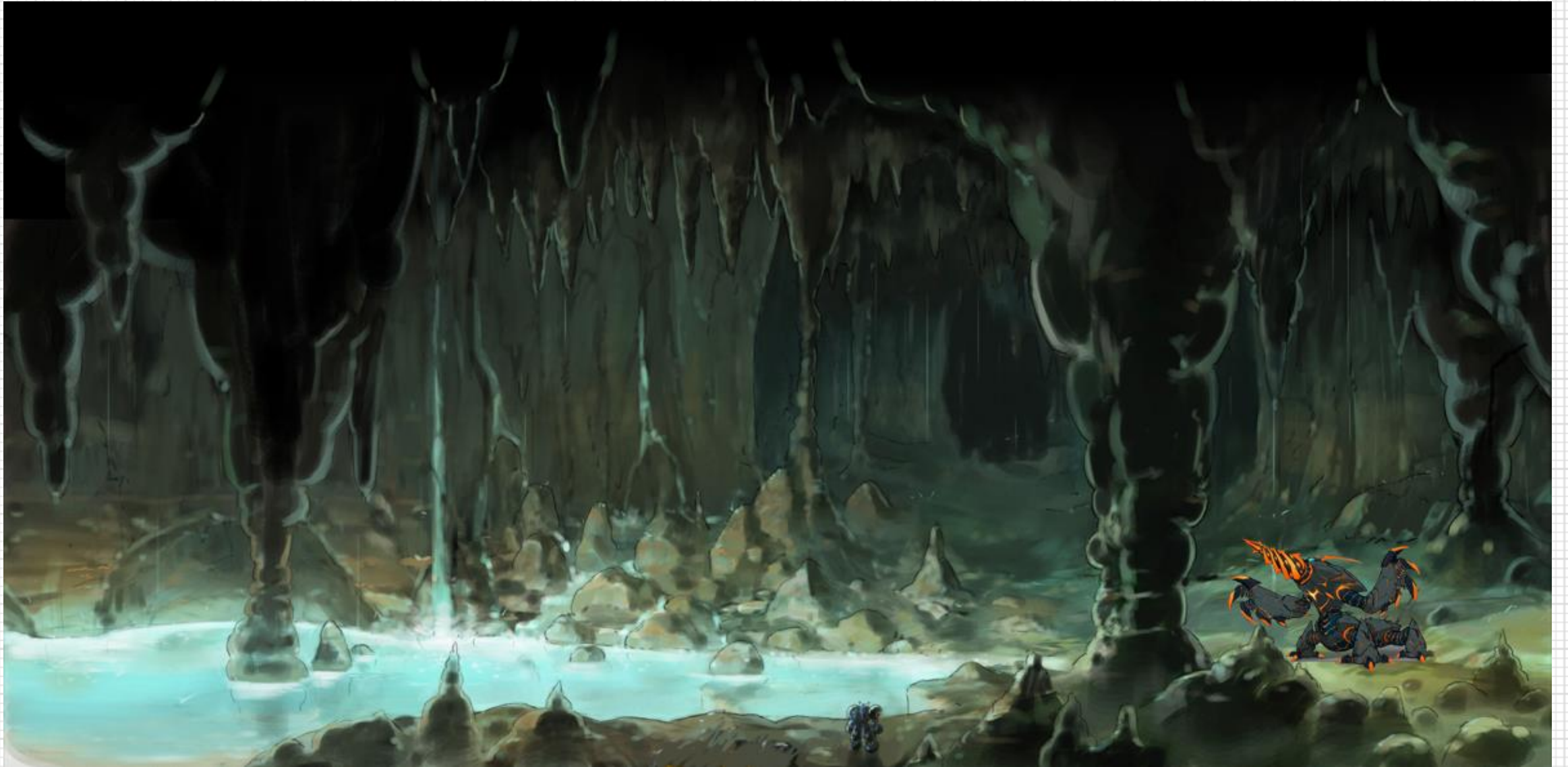



## ■東郷門 入口の門 昼

東郷内 / 入口の内 / 昼

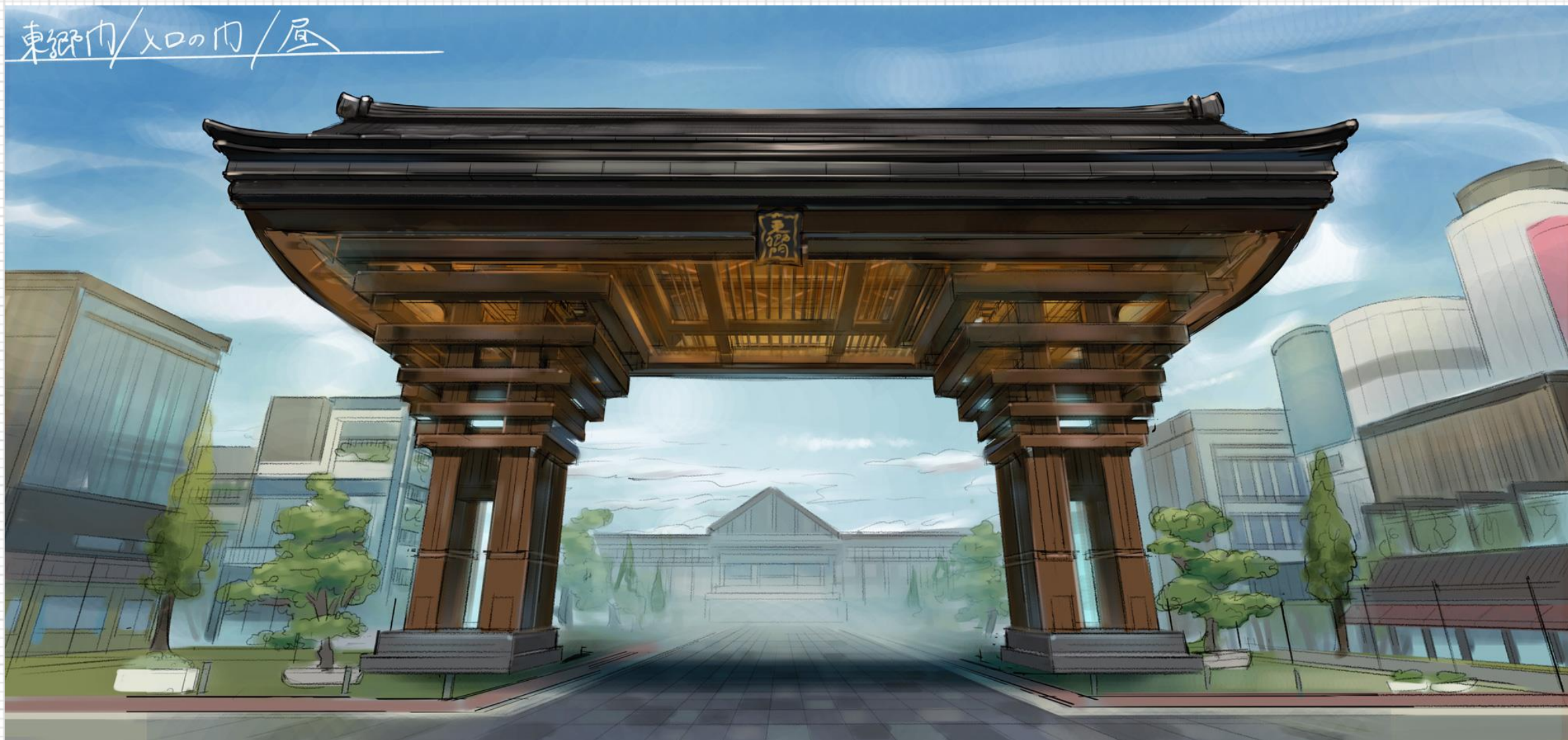



## ■東郷門 入口の門 夜

東郷門 / 入口の門 / 夜





## ■東郷門 ショッピングモール





## ■西の平原 墜落村

